



INSTALLATION & MAINTENANCE GUIDE



TED TODD

Notes on Timber Floors	5
INSTALLER'S RESPONSIBILITY	6
CHAPTER 1 - JOBSITE CONDITIONS	7
1.0 Understanding project requirements	7
1.1 Minimum Jobsite Requirements	7
1.2 Access to underfloor services	9
1.3 Additional Jobsite Conditions for Pre-finished Flooring	9
1.4 Inspection of the floor	9
1.5 Jobsite Checklist	10
CHAPTER 2 - MOISTURE TESTING AND VAPOUR RETARDERS	11
2.1 Wood Subfloors	11
2.1.1 - Moisture Testing	11
2.1.2 – Vapour Retarders	11
2.2 Concrete Slabs	12
2.2.1 Types of test	12
2.2.2 - Moisture Testing	12
2.2.3 - Vapour Retarders	13
CHAPTER 3 - ACCLIMATISATION	13
3.1 Site Checks	13
3.2 Acclimatisation	13
CHAPTER 4 - ACCEPTABLE SUB FLOORS	15
4.1 - General Sub Floor Requirements.	15
Sub floor Moisture.	15
Sub floor Flatness and Integrity	15
4.2 - Panel Products Subfloors.	16
4.3 - Solid Board Sub floors	17
4.4 – Joists	18
4.5 Tiled Sub Floors	18
4.6 - Concrete Subfloors	19
4.6.4 Specifications for Lightweight Concrete	19
4.7 - Mixed Sub Floors	20
CHAPTER 5 – PARQUET, CHEVRON & PANEL INSTALLATION	21
5.1 Site Checks	21
5.2 Acceptable Sub Floors	21
5.3 Installation Guidelines	21
5.4 Parquet Layouts	21



5.4.1 Square Layout from the Centre of the Room	22
5.4.2 Diagonal Layout from the Centre of the Room	22
5.4.3 Installation of Herringbone Using Square or Diagonal Layout	23
5.4.2.1 Alternative Herringbone Installation Using Square or Diagonal Layout	23
5.4.3 Square Layout from the Wall	24
5.4.4 Installation Using Wall Layout	25
5.5 Extra Consideration When Installing Chevron Parquet Flooring	27
5.5.1 Qualified and experienced professional for installation	27
5.5.2 Sub-floor Flatness is of Paramount Importance	27
5.5.3 Expansion and Contraction of Wood Blocks	27
5.5.4 Installation Considerations	27
5.5.5 Installation Using Plywood Guide	28
5.6 Additional considerations when installing engineered, patterned panels	29
5.6.1 Installation of engineered flooring panels requires high technical ability	29
5.6.2 Sub-floor flatness is of paramount importance	29
5.6.3. General guidelines	29
5.6.4 Layout	29
5.6.5. Tongue and Groove	30
5.6.6. Installation	30
CHAPTER 6 - ENGINEERED PLANK WOOD FLOORING INSTALLATION	31
6.1 Site Checks	31
6.2 Acceptable Sub Floors	31
6.3 Installation Guidelines	31
6.3.1 Glue Down Installation	33
6.3.2 Nail Down Installation	33
6.3.3 Floating Plank Installation.	34
CHAPTER 7 - SOLID PLANK FLOORING INSTALLATION	35
7.1 Site Checks	35
7.2 Acceptable Sub Floors	35
7.3 Installation Guidelines.	35
7.3.1 Glue Down Installation	36
7.3.2 Nail Down Installation	36
CHAPTER 8 - UNDERFLOOR HEATING (UFH)	38
8.1 General Guidelines	38
8.2 Water Fed Systems	39
8.3 Electric Systems	40
8.4 Heating Systems Over Suspended Floors	40



CHAPTER 9 - REACTION TO FIRE	41
APPENDIX A - SAFETY GUIDELINES	42
Safety first	42
APPENDIX B - EQUILIBRIUM MOISTURE CONTENT OF WOOD SPECIES AT VARIOUS TEMPERATURES AND RELATIVE HUMIDITY READINGS.	43
Temperatures and Relative Humidity Readings	43
Coefficients of Change: How Moisture Affects Wood Flooring	43
APPENDIX C - PROPER INSTALLATION BY CALCULATING COEFFICIENTS OF CHANGE	44
APPENDIX D - TRAMMEL POINT METHOD	46
Trammel Points	46
Trammel Point Method for Squaring a Room and Finding the Centre	46
APPENDIX E - SOUND CONTROL	48
Installation.	48
Sound Control Product Types	48
APPENDIX F - MOULDINGS USED WITH HARDWOOD FLOORS	49
APPENDIX G - JOBSITE CHECKLIST	50
Job Site Checklist	51
APPENDIX H - FORMALDEHYDE RELEASE	55
APPENDIX I - CARE AND MAINTENANCE. TED TODD FLOOR CARE SYSTEMS.	56
I.1 – Lacquered, Hardened oil (UV Oiled) and Oilwood Traffic finishes. Care System 1.	58
I.3 Cleaning Schedule for Contract Flooring Installations.	58
I.3.1 Care System 1 for UV Lacquer, Hardened Oil, UV Oil and Oil Wood Traffic.	58
I.3.2 Care System 2. Natural Oil, Hard Wax Oils and Restoration Oil finishes.	59
I.4 Cleaning Schedule for Residential Flooring Installations	60
I.4.1 Care System 1 for Lacquers / Hardened oils/ UV Oils / Oil Wood Traffic	60
I.4.2 Care System 2. Natural Oil, Hard Wax Oils and Restoration Oil finishes.	60
APPENDIX J – STOCK CODES OF KEY ESSENTIAL PRODUCTS	61



NOTES ON TIMBER FLOORS

Wood flooring is a hygroscopic material subject to dimensional change as a result of variations in moisture, temperature and humidity in the surrounding environment. This has led to increasing awareness of the need to maintain an environment that is acceptable for wood floors. Wood flooring simply needs to be in equilibrium with the surrounding environment in which it will be installed, at or near normal living conditions. Always account for time of year and geographic location.

Our floors are kiln dried to within 8% and 12% which is the moisture content range that the floor would naturally achieve when installed in an environment which is controlled to stay within a relative humidity range of 40% to 60% and a temperature range of 15°C to 26°. When the floor is neither gaining nor losing moisture this is known as the equilibrium moisture content (EMC).

Ted Todd recommends that the environment be controlled to stay within these parameters even when the property is unoccupied. If, due to the geographical location, seasonal variation is outside of these parameters the extra expansion or contraction must be allowed for in the fitting. This is also true when using an installation with underfloor heating which may dry the wood floor to typically 6% to 8%. This must be considered during the installation.

NOTE: Not properly controlling your environment may cause excessive expansion, shrinkage, splitting, dimensional distortion or structural damage

The point of acclimatising wood flooring before installation is to allow the temperature of the wood to adjust to the installation site's normal living conditions, having controlled the humidity conditions and moisture content that will typically be experienced once the premise is occupied.

For site-finished wood flooring, allow the flooring to stabilize for a further period of time after installation, before finishing.

It will cause problems if wood flooring is stored at the jobsite in an uncontrolled environment, especially one that is subject to excessive moisture and humidity. It is likely to be harmful to store wood flooring at the jobsite under conditions that don't reflect those normal environmental conditions. Garages, basements and exterior patios, for example, are not acceptable areas to store wood flooring.



INSTALLER'S RESPONSIBILITY

IMPORTANT!

It is the installer's responsibility to carry out the final inspection of the floor prior to installation to ensure the colour, grade, quality, manufacture and factory finish of the product is acceptable.

Before final installation, the product must be checked with the end user to ensure the correct product has been supplied, and that the end user is happy with the product.

Additionally, the inspection of all pieces of the floor must be done before those pieces are installed. Carefully examine the flooring for colour, finish and quality before installing it. The installer must open several packs of the floor at a time to enable a good colour and grade mix across the installation, use reasonable selectivity when choosing the layout of the boards and hold out or cut off pieces with deficiencies, whatever the cause. If the product is deemed not acceptable for any reason, do not install it and contact your supplier immediately.

Once a product has been laid and later discovered to be incorrect, or for any boards with defects or visual irregularities that should have been spotted at the time of installation, no financial assistance can be given, nor can the product be returned.



CHAPTER 1 - JOBSITE CONDITIONS

1.0. Refer also to BS8201-2011, Section 5- Care on site, Section 6-Exchange of information and Section 7, Time Schedules.

In order for the wood flooring to be correctly installed under appropriate conditions, all parties should have a clear understanding of the requirements of the project (See BS8201 section 6 for a comprehensive listing) and of the implications for all concerned. To ensure that this is achieved, there should be wide consultation between all parties involved in the project, including sub-contractors and materials suppliers. This consultation should start early in the design stage but is necessary throughout the contract, especially if requirements or the time scale change and as new contract work is initiated.

1.1 Minimum Jobsite Requirements

- Wood flooring should be one of the last jobs completed on the construction project. Limit foot traffic on finished wood flooring.
- Evaluate the jobsite for potential problems before installation begins, and before the wood flooring is delivered to the jobsite.
- Ensure any water pipes, if present in the sub floor, are at an adequate level or insulated so as not to compromise the installation and/or cause any effect on the timber after installation. Failure to insulate can cause localized shrinkage of the floor boards.
- Ensure electrical wires, if present in the sub floor, are at an adequate level to not interfere with the installation.
- Subfloors (wood or concrete) should be checked by an appropriate method for establishing moisture content. Average subfloor moisture content should be within the range as specified in Chapter 2 - Moisture Testing.
- For a comprehensive listing of sub-floor types and construction layouts, please refer to BS8201, Section 3, Figures 1 to 3. Sub floors should comply with these standards.
- Unless a waiver or letter of protest listing exceptions exists, installation constitutes acceptance of subfloor/substrate, the jobsite itself - including the ambient temperature and relative humidity at the time of installation, and all impacting variables that may affect a wood floor.
- Wood shavings and other debris should be prevented from accumulating under a floor as this can lead to a fire hazard or to infestation by vermin.
- Surface drainage should direct water away from the building.
- Do not deliver wood flooring to the jobsite or install wood flooring until the building is enclosed.
- If heating and/or air-conditioning is in operating condition, it needs to be operating. If it is not possible for the permanent heating and/or air-conditioning system to be operating before, during and after installation, a temporary heating and/or dehumidification system that mimics normal temperature and humidity conditions can enable the installation to proceed until the permanent heating and/or air-conditioning system is operating.
- Do not deliver wood flooring to the jobsite, or install wood flooring until appropriate temperature and humidity conditions have been achieved. Appropriate temperature and humidity conditions are defined as those conditions to be experienced in the building after occupancy.



- Do not deliver wood flooring to the jobsite or install wood flooring until all concrete, masonry, plastering, drywall, texturing and painting primer coats are completed, the humidity has been checked and within guidelines.
- Barrier Matting Zone. At the design stage, consideration must be given to the use of barrier matting especially in any entrances open to the outside.
- Basements and crawl spaces must be dry. If power washing is required in the basement, do so before wood flooring is installed and allow subfloor and basement to dry before installing wood flooring.
- Crawl space should be a minimum of 457mm from ground to underside of joists.
- Crawl space earth (or thin concrete slab) should be covered 100% by a vapour barrier of polyethylene (minimum 1000 gauge) or other recommended puncture-resistant membrane. Vapour retarder joints should be well-overlapped and taped and be extended and sealed at least 150mm up the stem wall.
- When venting is required a gap of at least 1500mm² per linear metre run should be allowed on each side.
- Note the ground level at the exterior of the building and if the soil or any exterior feature is more than 75mm above the floor then the floor must be treated as below ground level and engineered flooring only should be used.
- Where the minimum jobsite conditions are present, the flooring can be delivered and stored in the rooms in which it will be installed. See Chapter 3, Acclimatisation.



1.2 Access to underfloor services

Access to underfloor services

Adequate provision should be made for subsequent access to services. Sockets or service ducts set in the base should be positioned and fixed before laying commences. Access covers should be adjusted to the final floor level and, where applicable, depth left to suit the overall thickness of the floor finish for infilling of recessed access covers. The design should take into account the required movement/expansion of the wood flooring.

NOTE At access points, it might be necessary to remove the tongue from tongued and grooved boards.

Treatment of pipes

Where hot water or steam pipes (other than those for underfloor heating purposes) pass under the flooring, they should be lagged or otherwise insulated to reduce localized shrinkage of the flooring in that area and they should be fixed at a sufficient depth to avoid possible damage from fixings for the new flooring. Compliant insulation materials should be used to accommodate thermal movement of pipes.

1.3 Additional Jobsite Conditions for Pre-finished Flooring

- All finished wall coverings and painting should be completed. Note: Skirting or scotia may be installed and finished after the flooring installation.
- After installation, if you choose to protectively cover the floor, cover the floor completely with a floor protection product since some species are light-sensitive and uncovered areas may change colour. However, covering a glue-down application may not allow some adhesives to properly cure. Follow the flooring and adhesive manufacturer's recommendations. Use a covering material that is vapour permeable to avoid trapping moisture/vapour on or within the floor. A common reinforced builder's paper is a good choice. Any covering should be taped, using a low-adhesion tape, to base or skirting.

Avoid taping to the finished flooring. When taping paper or sheets together ensure they are taped to each other and not to the floor.

1.4 Inspection of the floor

During installation of the floor and before final handover, the installation should be checked and inspected according to BS8201-2011.

If the floor is regularly inspected during the installation, then any potential issues may be identified and rectified rather than waiting until the installation is complete.

Floors should be inspected from a normal viewing position either standing or seated. When viewing the floor, only those features which are immediately obvious to any independent party should be considered as potential defect issues.

NOTE Careful positioning of backlighting or unusual viewing angles (crouching or kneeling, etc.) would not be considered reasonable criteria for identifying a visual defect. The overall appearance of the floor should be consistent (product and installation) unless intentional as part of the product design or pattern.



1.5 Jobsite Checklist

SEE APPENDIX K



CHAPTER 2 - MOISTURE TESTING AND VAPOUR RETARDERS

Below are some basic guidelines regarding sub floors and moisture testing.

For a more comprehensive set of guidelines regarding elimination of construction moisture, please refer to BS8201- 2011, section 12.4.6 .

It is imperative all sub floors are tested for moisture prior to bringing the flooring into the property. This should include recording of all measurements taken including; the date, relative humidity, ambient temperature, type of meter, along with a plan of test locations.

Ensure jobsite conditions are met prior to conducting moisture testing.

NOTE: All tests give a result at the time the test is done. In general they give you the ability to start or not start a job. These tests do not give a permanent condition of your substrate merely an "at the time the test was performed" indication.

The use of vapour retarders reduces the potential moisture related problems; Ted Todd recommends the use of vapour retarders with all installations

2.1 Wood Subfloors

2.1.1 Moisture Testing

Test for moisture at several locations in the room, a minimum of 20 points per 93 square meters averaging the results.

Test for moisture using an electrical resistance moisture meter, ensuring tests are taken with the moisture probes placed in line with the grain.

Target moisture content of wood sub floor should not exceed 12% or be greater than 2% of the moisture content of the floor.

A high reading in one area indicates a problem that must be corrected. Pay special attention to exterior walls and plumbing.

2.1.2 Vapour Retarders

Ted Todd recommend using Sisalkraft 728 Builders paper for all nail down installations and one of the Ted Todd professional underlays with taped seams for all floated installations over wood sub floors. (See Section 6.3.3 for choice of underlay.)

The vapour retarder underlays have some extra benefits in that they eliminate wood-on-wood contact, planks slide more easily when positioning, they minimise the impact of seasonal humidity change and may reduce dust and noise levels.

Over a wood subfloor, do not use an impermeable vapour retarder material such as Ted Todd Moisture Screen Foil or other impermeable materials, as it may trap moisture on or in the wood subfloor.



2.2 Concrete Slabs

2.2.1 Types of test

There are several types of test for measuring the moisture content of a concrete screed:

Concrete Encounter

Non-destructive, very quick, surface test;

Calcium Carbide Test Destructive, quick and very accurate;

Relative Humidity (NB, not to be confused with the Relative Humidity of the ambient atmosphere in the room)

Non-destructive, slow but very accurate.

Each test has its advantages and disadvantages. British Standards 8201:2011 recommends using Relative Humidity testing of concrete sub floors. However to comply with requirements set by the installation products. Ted Todd recommends testing using the Calcium Carbide method.

2.2.2 Moisture Testing

Before moisture testing begins, the concrete screed must be a MINIMUM of 30 days old. As a very rough guideline, for up to 40mm thickness allow drying time 1 day per mm of new concrete screed, (minimum 30 days) and an additional 2 days per mm above this.

For Anhydrite, Calcium Sulphate or similar screeds the guidelines as above should be followed but the laitance (the surface layer after curing) should be removed as soon as possible after curing to allow the moisture to escape.

Select test locations to provide information about moisture distribution across the entire concrete floor slab. For slabs on ground and below ground, include a test location within 1 metre of each exterior wall.

Perform ten tests for the first 93m² and one test for every additional 93m² thereafter. The actual test area should be clean and free of all foreign substances. Use approved work practices for removal of all existing flooring materials and debris.

A high reading in one area indicates a problem that must be corrected. Pay special attention to exterior walls and plumbing

Always follow the meter manufacturer's instructions for use and ensure the correct calibration for the method and material being tested so that a reading of moisture content, by weight, of the concrete screed is obtained.

Target moisture content of concrete screed should not exceed 2%. (See 2.2.3 below ref Vapour Retarders)

If a Gypsum / Anhydrite screed is used, the target moisture content should be below 0.5%, or below 0.3% if Under Floor Heating is being used. (NB readings must be taken once any laitance layers are removed.)



2.2.3 Vapour Retarders

Ted Todd recommends using Ted Todd Primerfast liquid damp proof membrane (LDPM) prior to ALL glue-down installations and the appropriate Ted Todd professional underlay for ALL floated installations. (See section 6.3.3, Floating Plank Installation, for choice of underlay)

If the calcium carbide method test gave a reading for a concrete sub floor of greater than 2% moisture reading but no more than 4%, with a 60mm thick screed or less, using Ted Todd Primerfast liquid damp proof membrane can allow you to continue with the installation. If measurements are outside of these parameters do not bring the floor onto site.

When using Ted Todd underlays all seams must be taped with either Ted Todd Aluminium Tape or the self-adhesive overlap tape where this exists.

If the installation is over water fed under floor heating system do not use Ted Todd Primerfast. One coat can be used if required to seal a loose screed.

Once a Gypsum/Anhydrite screed is deemed dry [usually 0.5% by the calcium carbide method, or in the case of UFH 0.3%] it is often good practice to protect the screed from moisture ingress from spillages, burst pipes, wet trades etc. In this instance and only when the screed is completely dry, the use of a liquid applied damp proof membrane (Ted Todd Primerfast) can be applied to the surface.

For all floated installations over under floor heating (UFH) use the appropriate Ted Todd Underlay with taped seams. (see section 6.3.3)

Ensure that all installations with UFH are equipped with the Ted Todd Fidbox monitoring system.

CHAPTER 3 - ACCLIMATISATION

3.1 Site Checks

Before bringing the timber onto site ensure the requirements have been met for

Jobsite Conditions (Chapter 1)

Moisture Testing (Chapter 2)

3.2 Acclimatisation

Ted Todd recommends that all floors are acclimatised within their packs for 2 to 3 days in the room to be installed to allow the temperature of the floor to equalize with its environment ensuring job site conditions are met.

Ensure that the building is enclosed.

Verify that the building is maintained at normal living conditions for temperature and humidity. Where building codes allow, permanent heating and/or air-conditioning systems should be operating at least five days preceding installation to promote proper acclimatisation.



If it is not possible for the permanent heating and/or air-conditioning system to be operating before, during and after installation, a temporary heating and/or dehumidification system that will mimic normal temperature and humidity conditions can enable the installation to proceed until the permanent heating and/or air-conditioning system is operating.

Packs should be stacked flat on the floor or on battens (not upright) allowing for airflow around the stacks.

If the delivery is for more than one room the order should be broken down into the individual room quantities and stored in the respective rooms.

Extra acclimatisation may be required when using underfloor heating. See Chapter 8.



CHAPTER 4 - ACCEPTABLE SUB FLOORS

4.1 General Sub Floor Requirements.

For a comprehensive listing of sub-floor types and construction layouts, please refer to BS8201, Section 3, Figures 1 to 3. All sub-floors must comply with BS8201-2011.

Ted Todd wood floors can be installed over a variety of sub floors. Please refer to the following sections for minimum sub floor specifications:

- 4.2 Panel Products;
- 4.3 Solid-board softwoods;
- 4.4 Joists;
- 4.5 Tiles;
- 4.6 Concrete Screed;
- 4.7 Mixed Sub Floors.

Sub floor Moisture.

Always check moisture content of wood flooring on both sides before installing. Ensure moisture content of sub-floor/substrate meets the appropriate industry standard for the finish flooring material to be installed.

For wood sub floors there should be no more than 2% difference in moisture content between wood flooring and subflooring materials.

For concrete screeds moisture content should not exceed 2% (calcium carbide measure) moisture content.

Sub floor Flatness and Integrity

Sub floors must be flat to within flatness tolerance of a maximum 3 mm gap showing under a 2 m long straight-edge. The sub floor must also be clean, dry, structurally sound, free of squeaks and free of protruding fasteners

If peaks or valleys in the subfloor exceed the tolerances specified above, level with approved material for use under wood flooring. However, it is usually the builder's or general contractor's responsibility to provide the wood-flooring contractor with a subfloor that is within the tolerances listed above.

Inspect the sub floor carefully. If there is movement or squeaks in the subfloor, refasten the subfloor to the joists in problem areas. Any protruding fasteners within the sub-floor should be dealt with.



Sub floor deviation from level, as defined by BS8201 – 2011, section 12.4.2.2.

The maximum permissible deviation from the level, or from a specified datum, of the finished floor should be specified, taking into account the area of the floor and its end use. For large areas (greater than 25 m²), a deviation of 15 mm from the datum is generally considered to be satisfactory. Greater accuracy to datum can be necessary in small rooms, along the line of partitions walls, in the vicinity of door openings etc. For an area under 5 m × 5 m, a maximum deviation of 5 mm from datum is considered acceptable.

4.2 Panel Products Subfloors.**Sub floor Must Be Flat.**

Make sure the panels are flat within a flatness tolerance of a maximum 3 mm gap showing under a 2 m long straight edge. If the panels are out of specification, consider sanding.

When sanding care must be taken to minimize the amount of dust produced. Best practice would include using dust-collection devices. Approved respirators should also be used to minimize the amount of dust inhaled.

Sub floor Must Be Dry.

Refer Chapter 2, Moisture Testing.

Specification.

For panel products subflooring, check for loose panels and re-nail or screw down loose panels securely.

Check that the installation meets the standards of BS8201-2011.

Ensure that there is proper expansion space (3mm) between the panels. If the subfloor panels are not tongue-and-grooved and if there is not sufficient expansion space, use a circular saw to create the specified space. Do not saw through joints on T&G subfloors.

Also check for delaminated or damaged areas and repair those areas as needed. Make sure the subfloor is clean and free of debris before beginning installation.

Ensure that panel sub-floors over joists meet with current local building regulations with regard to the panels' structure and thickness and joist centres spacing.

Fastening and Spacing Specifications

Follow the panel manufacturer's recommendations for spacing and fastening.

Only use fixings and fasteners that comply with BS8201-2011, section 12.7.

Typical panel spacing and fastening requirements for truss/joist systems call for a 3mm expansion space around the perimeter of each panel, with panels fastened every 300 mm along intermediate supports.

Edge swell should also be flattened. This can usually be accomplished by using an edger sander.



4.3 Solid Board Sub floors - (existing plank floor boards)

Sub floor Must Be Flat

Make sure the boards are flat to within 3mm in 2m radius

If the boards are out of specification, consider sanding.

When sanding care must be taken to minimize the amount of dust produced. Best practice would include using dust-collection devices. Approved respirators should also be used to minimize the amount of dust inhaled.

Sub Floor Must Be Dry

Refer Chapter 2, Moisture Testing.

Specification

Ensure that the Solid board sub flooring (existing floorboards) meet all relevant building regulations and that the installation is structurally sound with no signs of rot or infestation.

We do not recommend installing parquet flooring directly onto existing floorboards without the use of minimum 9mm ply panel underlayment installed according to BS8201-2011.



4.4 Joists

Only acceptable for 20mm solid or engineered floors.

Sub floor Must Be Flat

Make sure the joists are flat to within a flatness tolerance of a maximum 3 mm gap showing under a 2 m long straight edge

Sub floor Must Be Dry

Refer Chapter 2, Moisture Testing.

Specification

Check carefully the relevant building regulations with regard to the structure, floorboards thickness and joist centres to ensure that the installation is structurally compliant and safe.

4.5 Tiled Sub Floors

Sub floor Must Be Flat

Make sure the tiles are flat to within 3mm in 2m radius.

Sub floor Must Be Dry

Refer Chapter 2, Moisture Testing.

Specification

Engineered and solid flooring can be installed directly over existing ceramic tile, terrazzo, marble and granite.



4.6 Concrete Subfloors All subfloors must be installed and comply with BS8201-2011.

Sub floor Must Be Flat

Make sure the concrete slab is flat to within a flatness tolerance of a maximum 3 mm gap showing under a 2 m long straight edge

If the slab is out of specification, consider grinding, floating or both. Many high spots can be removed by grinding, depressions can be filled with approved levelling compounds and slabs can also be flattened using a self-levelling concrete product.

When sanding or grinding concrete, care must be taken to minimize the amount of dust produced. Best practice would include using dust-collection devices or applying water to the concrete before sanding. Approved respirators should also be used to minimize the amount of silica dust inhaled.

Sub floor Must Be Dry

Refer Chapter 2, Moisture Testing.

Slab Must Be:

- Minimum 3000 psi
- Free from non-compatible sealers, waxes, and oil, paint, drywall compound etc.
- Check for the presence of sealers by applying drops of water to the slab, if the water beads up, there may be sealers or oils.
- Do not attempt to glue a wood floor over a chalky or soft concrete slab.
- Burnished, slick steel-trowel slabs and power floated slabs may require screening with a 30-grit abrasive and using Ted Todd Primerfast as a primer once the screed is fully dry.

Specifications for Lightweight Concrete

Make sure the concrete is well bonded to the sub-floor. Check for hollow spots, cracks and loose areas.

As with on-ground concrete sub-floors make sure the concrete is clean, flat to specification and dry.

Over lightweight concrete (less than 3000 psi), only float engineered floors directly over the sub floor.

Rule of thumb: Draw a nail across the top; if it leaves an indentation, it is probably lightweight concrete.

For wide solid boards a ply sub floor can be installed over a concrete screed using nominal 15mm Class 1 Exposure ply wood sub floor panels installed according to BS8201-2011.



4.7 Mixed Sub Floors

For areas with mixed sub floors, most commonly extensions whereby the ground floor has a suspended floor and the room is extended with a concrete screed, it is important to level the entire area and to ensure the ridge between the two areas is removed.

Only use one fitting method to install the floor in the area unless the floor is separated by the use of a T section at the join of the sub floors.

If only part of a continuous floor area is to be fitted with UFH, it is recommended that the heated area is separated from the un-heated area by a break in the wood flooring using a T-bar section. This is to avoid any differential in expansion / shrinkage of the two areas that may lead to splitting, cracking, open joints or a squeaky installation.

The best way to install the floor is to ply the entire area (see 4.2 - Panel Products Sub floors) and either nail or glue the flooring to the ply using only Ted Todd MS Flex adhesive.

Refer to section 2.1 and 2.2 to ensure the tolerance for moisture is met and the correct use of vapour retarders for each area.



CHAPTER 5 – PARQUET, CHEVRON & PANEL INSTALLATION

5.1 Site Checks

Before commencing installation ensure the requirements have been met for:

Jobsite Conditions (Chapter 1);

Moisture Testing (Chapter 2);

Acclimatisation (Chapter 3).

5.2 Acceptable Sub Floors

Refer to Chapter 4.

Parquet can be glued down, using Ted Todd MS Flex adhesive, over concrete or solid panel sub floors (see section 4.2). Other brands or types of adhesive should not be used.

Parquet cannot be installed directly on to solid board sub floors. A parquet installation over solid-board subflooring requires 9mm or better underlayment panels (see section 4.3).

5.3 Installation Guidelines

Always check with the end-user that the correct product has been delivered and that the end user is happy with the grade and visual appearance of the floor. Open several packs at a time and mix the pieces to ensure a good degree of selection so that the installation is visually well-balanced.

Parquet is recommended for glue down installation using Ted Todd MS Flex only.

Ensure Ted Todd Primerfast Vapour retarder has been applied unless with the use of under floor heating.

In installations with Under-floor Heating the Ted Todd Fidbox monitoring system must be used.

A minimum expansion space of 15mm must be left around the perimeter and all vertical obstructions.

A minimum expansion space of 15mm must be left around the perimeter and all vertical obstructions.

Please refer to Ted Todd's MS Flex and Primerfast data sheets, plus the instructions for using the Fidbox monitoring system.



5.4 Parquet Layouts

Parquet can be laid in many different designs. Consideration to the design you require will affect how you begin your installation.

To find the centre of the room refer to Appendix F - Trammel Point Method

5.4.1 Square Layout from the Centre of the Room

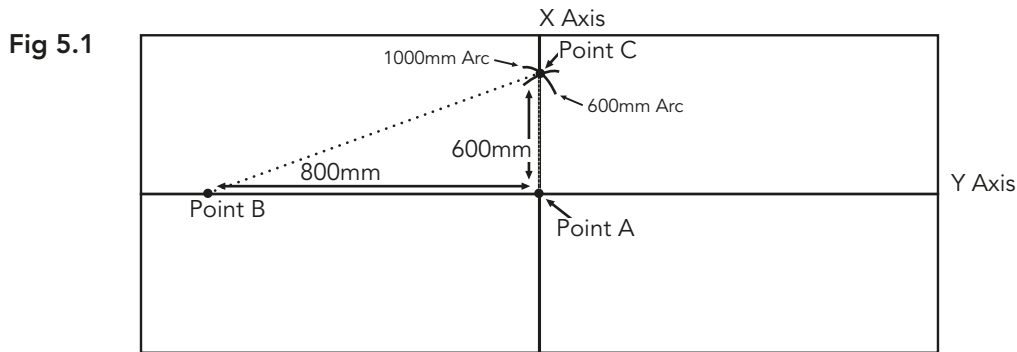

Start by snapping a chalk line through the centre of the room (line Y). The next line (X) must be exactly 90 degrees to line Y to form a perfect square corner. To ensure this angle, do the following:

From the centre point (A) of line Y, measure 800mm along line Y and mark that point (B); From the same centre point, measure 600mm in the general direction of where line X will be and scribe an arc;

Return to the original 800mm mark on line Y and measure 1000mm, scribing an arc that crosses (point C) the 600mm arc you made in the previous step (double check for accuracy by following a similar measurement and arc-scribing process on the other side of line Y and the opposite side from the expected position of line X)

Snap a chalk line through the conjunction of the two arcs at point C and the centre point of line Y. This will be line X, at an exact 90-degree angle to line Y.

5.4.2 Diagonal Layout from the Centre of the Room

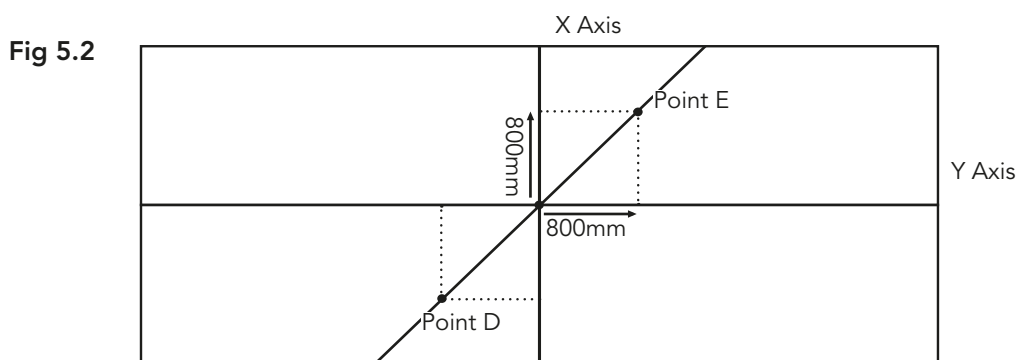

From the centre point, measure 800mm down in each direction on lines X and Y, which you have already determined by the method described above.

From each of these points, measure 800mm and scribe an arc. The conjunction of these arcs creates points D and E. Snap a chalk line between points D and E, and the centre point. This line represents a 45 degree angle.



5.4.3 Installation of Herringbone Using Square or Diagonal Layout

Use reference lines throughout the area that is being installed as shown in figure 5.3

Fig 5.3

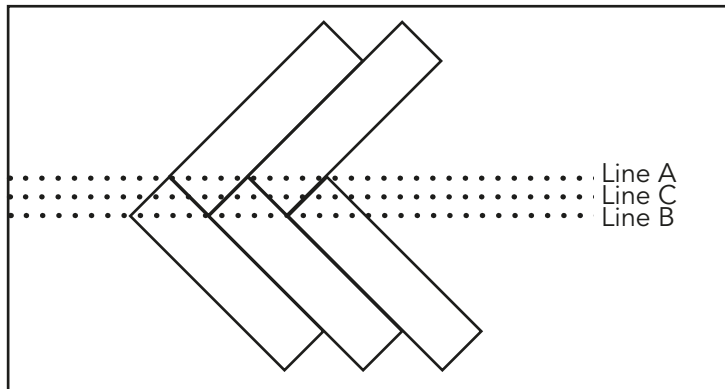

For basket weave and similar patterns the multiple of the width should equal the exact length of the piece. If the width of the product varies, this will cause separations at the end of the herringbone pieces.

Herringbone parquet can be laid out parallel or at a 45-degree angle to the room. Regardless of direction, Herringbone parquet will require a centreline and two working lines (See Figure 5-3).

Begin by laying out a few alternating slats. Snap lines A & B through the corners of the alternating slats (See Figure 5-3)

Measure the distance from Line A to Line B. Line C should be 1/2 that distance and run parallel to Lines A & B. The centreline of the room and the centre of the pattern is represented by Line C.

5.4.2.1 Alternative Herringbone Installation Using Square or Diagonal Layout

Fig 5.4

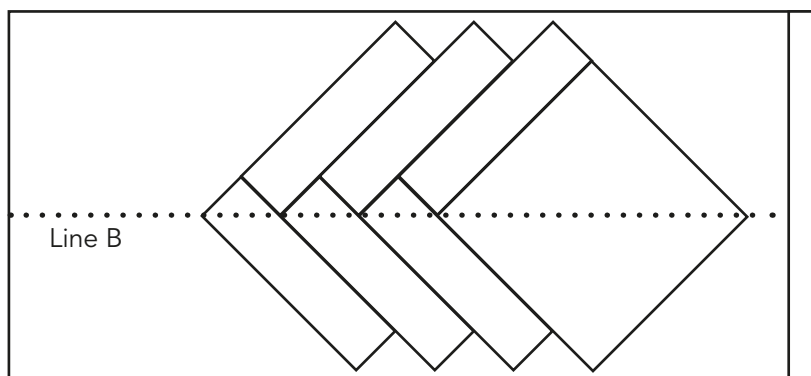

To begin installation on working Line B (See Figure 5-4), cut a square piece of plywood the size of the herringbone pattern. For example, if the herringbone pattern is 70mm by 230mm, cut a 230mm x 230mm square of plywood.

Fasten the piece of plywood at your starting point on Line B, with one corner of the square pointing in the direction of the pattern.



5.4.3 Square Layout from the Wall (See Figure 5-5)

Panels or basket weave parquet can be laid wall to wall without Centring the product in the room. The results will not be balanced but the products have no edge treatment to delineate the difference in sizes when unbalanced. More intricate patterns generally require the flooring to be centred.

If the room dimensions allow, in at least two places from the corner, measure out and establish a chalk line parallel to and the width of 2 panels plus 13mm away from the starting wall opposite the entrance doorway.

Start by snapping a chalk line and the width of 2 panels plus 13mm from the starting wall, opposite the entrance doorway (Line Y). The next line (X) must be exactly 90° to Line Y to form a perfect square corner. To ensure this angle:

Measure and the width of 2 panels plus 13mm along Line Y from the right-angle wall and mark it Point A. From Point A, measure 800mm along Line Y and mark that Point B.

From Point A, measure 600mm in the general direction of where line X will be and scribe an arc.

From Point B measure 1000mm, scribing an arc that crosses Point C. Verify all measurements before proceeding.

If correct, snap a chalk line through Point A and the conjunction of the two arcs at point C. This will be Line X, at an exact 90° angle to Line Y

Make any necessary adjustments to allow for walls out of square before proceeding.

Fig 5.5 - Creating 90° working lines from the wall

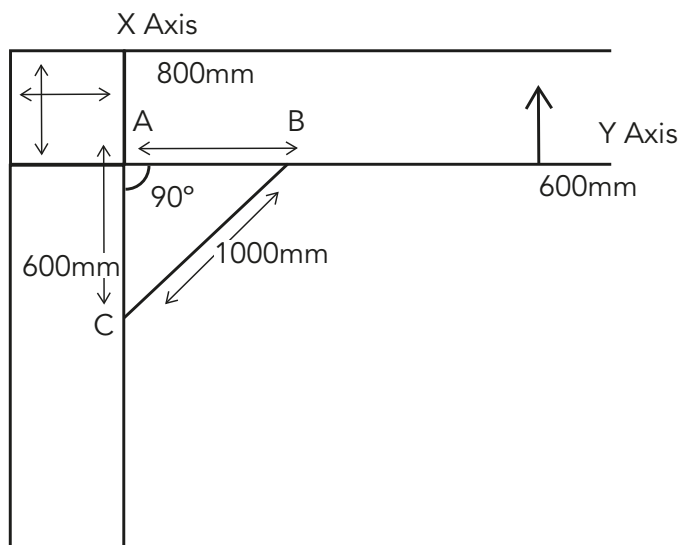

5.4.4 Installation Using Wall Layout

Fig 5.6

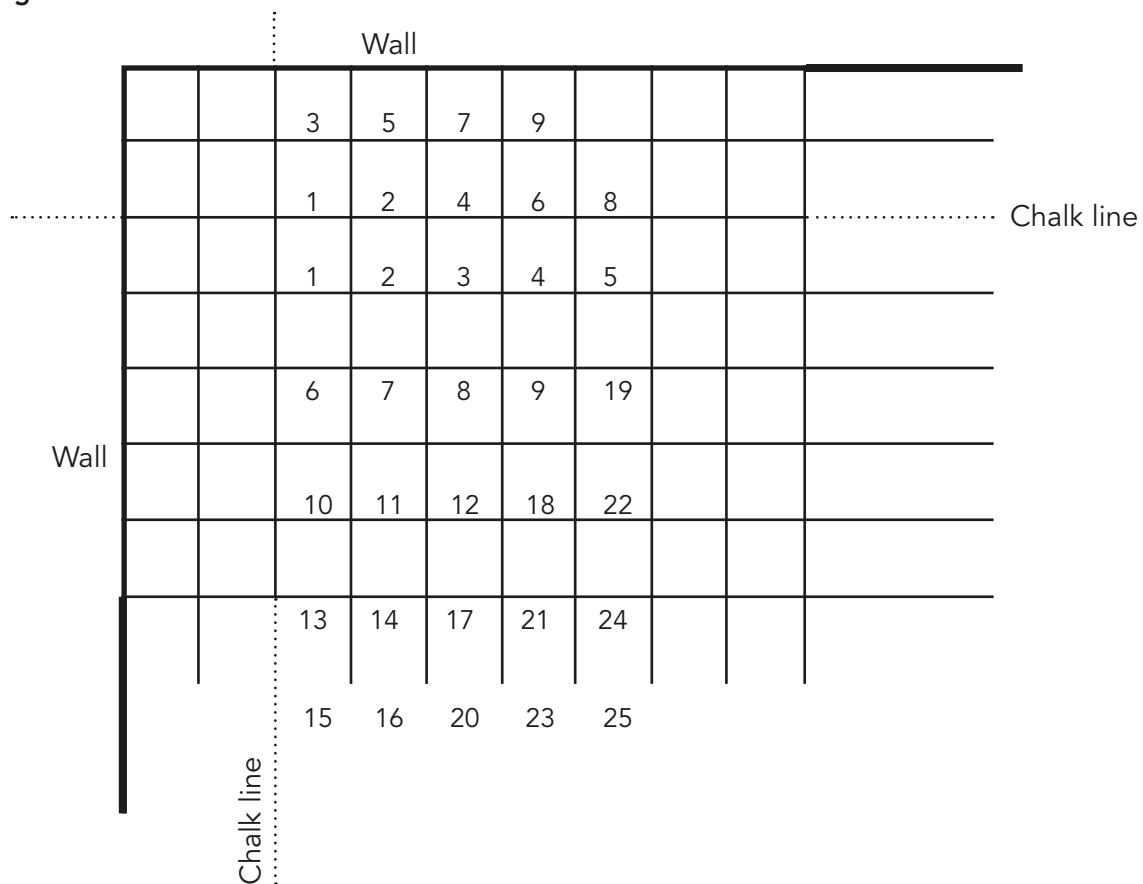

For patterns such as basket weave, the pattern can run out if installed wall to wall without checking for fitting tolerances. To avoid this, it is recommend fitting the blocks in a 5 x 5 pyramid pattern which will allow you to keep a constant check to ensure the pattern is not running out.

After setting out as described above build the pattern as shown. Once the pattern has been completed continue repeating this pattern across the floor.

The border can be completed along with the main area or left for completion after the main area has cured, when completing this area use a staggered pattern as shown.

After both chalk lines (at 90 degrees to each other) have been snapped, start spreading the Ted Todd MS Flex adhesive in the area to be Installed.

Continue spreading the adhesive in the working area. Be careful not to spread adhesive beyond the chalk line.

Immediately lay the product on the newly spread adhesive.

DO NOT lay the floor product on dry adhesive. If the adhesive becomes too dry, scrape up the old adhesive and spread more.



IMPORTANT: DO NOT stand or kneel on the newly laid floor during the installation to avoid shifting the blocks.

PROPER PLACEMENT OF THE FIRST BLOCK IS THE KEY TO THE ENTIRE INSTALLATION.

Carefully place a parquet block at the intersection of the two chalk lines. Do not use the edge of the tongue for aligning the block on the chalk lines.

Re-check to be sure the starting blocks are properly lined up with the chalk line. This is to assure a square starting area.

Do not push too strenuously as this as it could cause the first and second floor pieces to move. If this occurs simply realign them and proceed with the installation. Avoid hammering or forcing the components together as this may destroy the squareness of the product.

Maintain the 15 mm expansion space around the perimeter of the room and around all fixed objects.

Allow a minimum of 24 hours drying time before moving furniture or walking on the newly laid parquet floor.



5.5. Extra consideration when installing Chevron parquet flooring

5.5.1 NOTE:

Installation of chevron style flooring requires a high degree of technical ability and should only be performed by a qualified and experienced professional wood floor installer. It is not suitable as a DIY project nor suitable for installation by joiners or builders unless they are fully qualified professional wood floor installers.

Please note that to achieve a successful chevron flooring installation requires a very high degree of accuracy during both the manufacture and the installation.

Site conditions must be perfect and fully comply with the guidelines in sections 5.1 Site Conditions, 5.2 Acceptable Sub-floors, and 5.3 Installation.

5.5.2 Sub-floor flatness is of paramount importance.

Most installation problems can be traced back to an inadequately levelled sub floor.

5.5.3 Please note that in any chevron installation, the normal expansion and contraction of the wood blocks through natural humidity change will be enough to cause small gaps in the installation. This situation is particularly apparent with any installation of pre-finished chevron wood blocks. Please check with the end-client that this is acceptable and that the end-client has seen the appropriate large-format display panels in a Ted Todd Partner showroom or elsewhere. Up to 2mm deviation or gap is normal.

If the end client requires a chevron installation with improved visual accuracy, then the best results will be obtained by installing unfinished chevron blocks which can be filled and sanded after installation and finished on site.

5.5.4 Installation considerations.

Please note that the chevron blocks will be either Left Handed or Right Handed. Please determine whether the blocks have been supplied in opposite pairs in the same pack, or whether the left and right-handed pieces are supplied in separate packs.

Determine the layout for the floor and the direction the pattern will run. Once the sub-floor preparation is complete, mark the centre lines or angled lines in accordance with section 5.4.

Precise measurements are essential when laying a chevron pattern. Verify measurements and check row alignment frequently to ensure the pattern is being laid accurately and evenly.

To use as a guide to begin the installation, prepare a perfectly square piece of plywood 500mm x 500mm. Select your starting area in the middle of the room and affix the plywood guide to the sub-floor in a diamond position with the top and bottom points aligned with the centre line. (See diagram 5.7)

Open several packs of the chevron blocks, inspect the boards and loose lay the first section of flooring, both left and right sides. Ensure that the pattern is correct, that the points meet cleanly and that the short lengths make a perfectly straight line following the chalk lines.



5.5.5 Installation using ply wood guide

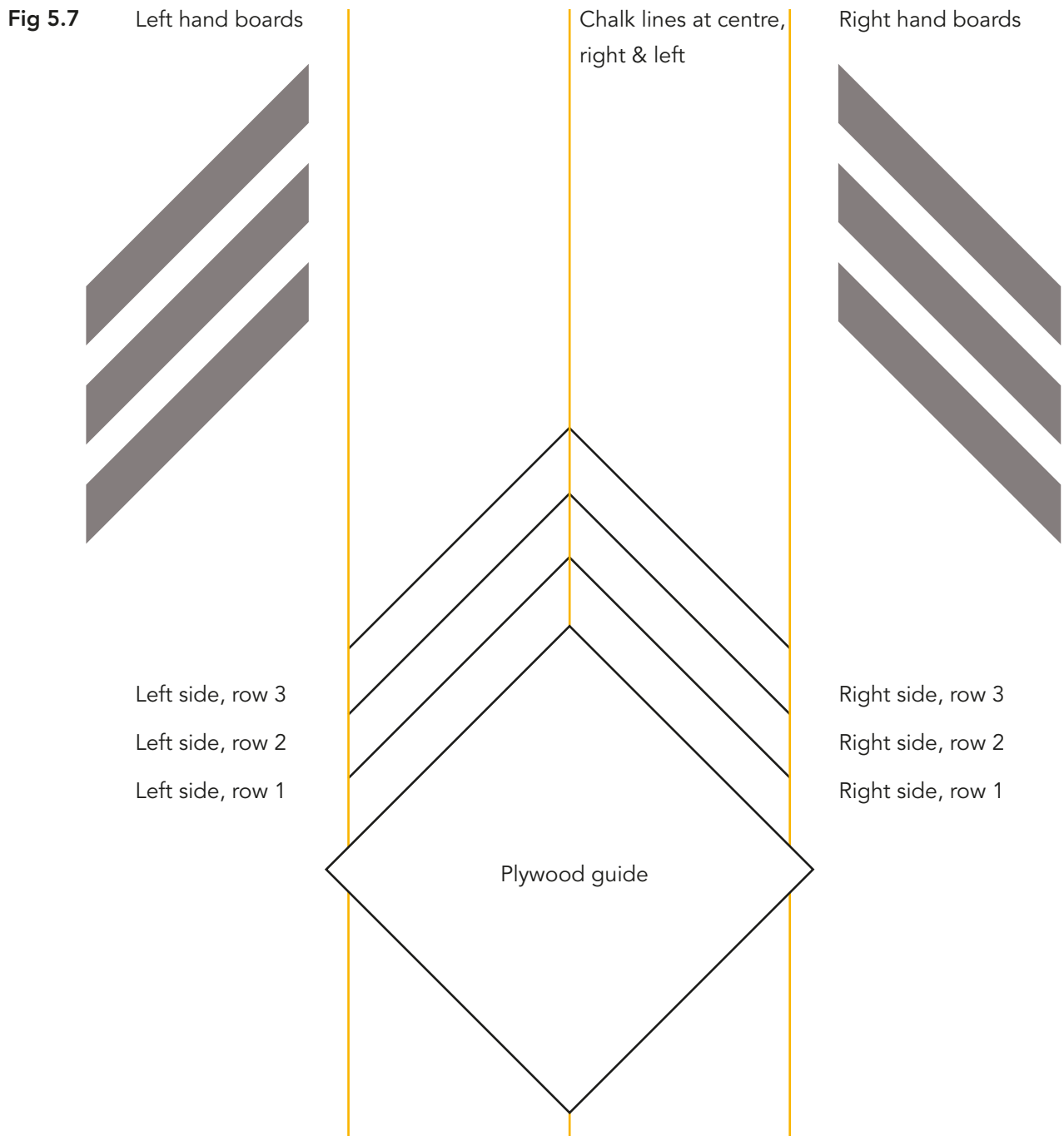

Once you are happy that the installation will be acceptable, apply the Ted Todd MS flex adhesive to the sub-floor and complete the installation of the first line both left and right sides.

Allow this to dry completely (up to 24 hours) and then use this initial column of glued-down chevrons as a start point for the remaining columns, having accurately marked out the centre, left and right chalk lines for each new column of chevrons.

If the short (header) joints are not already T&G profiled, consider using a loose tongue. That will minimise lipping at the points.

Remember to allow for normal expansion joint considerations.



5.6 Additional considerations when installing engineered, patterned panels such as Versailles, Chantilly, Jerdi etc.

5.6.1 Note: Installation of engineered flooring panels requires a high degree of technical ability and should only be performed by a qualified and experienced professional wood floor installer. It is not suitable as a DIY project nor suitable for installation by joiners or builders unless they are fully qualified professional wood floor installers.

Site conditions must be perfect and fully comply with the guidelines in sections 5.1 Site Conditions, 5.2 Acceptable Sub-floors, and 5.3 Installation.

5.6.2 Sub-floor flatness is of paramount importance.

Most installation problems can be traced back to an inadequately levelled sub floor.

5.6.3. General guidelines:

It is recommended that panels be installed fully bonded using Ted Todd MS Flex adhesive, preferably onto a flat plywood sub-floor, or onto a specially prepared flooring screed that meets conditions of dryness, flatness and structural integrity.

Panels should not be installed in a "floating" method.

5.6.4 Layout:

Before even ordering any panels, please check that the dimensions of the panels are understood, that the dimensions of the room or area to be installed are understood and that the general pattern and layout is agreed with the end client.

It should also be considered that the panels may be best arranged in a pattern diagonal to the room. This may make edge details around obstructions e.g. fireplaces, or out of square walls easier to deal with.

When planning the installation layout it is usual to start from the centre of the area to be installed.

Consideration will need to be given to the detailing of the outside edges of the room. It may be better to provide for some "Border Strips" of plank flooring to complete the edges.

If required, do order the border strips at the same time as the panels so that the finish and thickness can complement the panels.

Do remember to follow the general recommendations regarding expansion gaps, etc.



5.6.5. Tongue and Groove.

Panels may be supplied with differing T&G arrangements. Please check below:

(i) Panels may be supplied with 2 tongues and 2 grooves in which case there may be left and right-handed versions depending upon the pattern. Please check the layout before installing.

(ii) Panels may be supplied with 1 tongue and 3 grooves which should facilitate most pattern arrangements without left or right-handed versions. Please check the arrangement of the panels before installing. Loose tongues may be used to help the alignment of the panels on those edges where two grooves meet. Glue the loose tongues into the panels using Ted Todd T&G adhesive.

(iii) Panels may be supplied with 4 grooves which should facilitate all pattern arrangements without the need for left and right-handed panels. In this case the use of loose tongues in all joints is highly recommended to ensure tight alignment between the panels. Glue the loose tongues into the panels using Ted Todd T&G adhesive.

5.6.6. Installation:

Do follow the general recommendations for installation of a glue-down floor as well as the specific guidelines mentioned in this section (5.6) for installing panels.

Do always remember to start from the centre of the room or area to be installed and “dry-fit” the panels in the general orientation and gain approval from the end client. Similarly obtain agreement with end client that they are happy with the product as delivered, including grade, finish, etc.

Please check that dimensions of the panels as supplied are as expected!



CHAPTER 6 - ENGINEERED PLANK WOOD FLOORING INSTALLATION

Please refer to Chapter 8 under floor heating guidelines if system is present or to be installed.

6.1 Site Checks

Before commencing installation ensure the requirements have been met for:

Jobsite Conditions (Chapter 1) Moisture Testing (Chapter 2) Acclimatisation (Chapter 3).

6.2 Acceptable Sub Floors

Concrete Panel Plank

Joists - 20mm products only.

Tiles

6.3 Installation Guidelines

Always check with the end-user that the correct product has been delivered and that the end user is happy with the grade and visual appearance of the floor. Open several packs at a time and mix the boards to ensure a good degree of board selection so that the installation is visually well-balanced.

Choose a starting wall according to the most aesthetically or architecturally important elements in the room, taking into consideration fireplaces, doors, cabinets and transitions, as well as the squareness of the room. The starting wall will often be the longest unbroken wall in the room but do consider all other factors such as lighting.

Engineered wood floors can be glued to the existing sub floor using Ted Todd MS Flex adhesive or floated over an appropriate Ted Todd underlay and using Ted Todd T&G Adhesive to join the planks. 20mm thick products can be nailed to timber sub floors.

Ensure a DPM or vapour retarder has been applied unless with the use of under floor heating.

The Ted Todd Fidbox monitoring system must be Installed on installations with UFH.

Careful attention must be paid to the maximum area of the installation.

Do not float engineered floors where the dimension of an installation area exceeds 6m in width and 10m in length. If these dimensions are exceeded fully bond the flooring using Ted Todd's MS Flex adhesive.

For glue or nail installations where the maximum width exceeds 8m, extra expansion should be allowed in between the rows of the boards allowing 1mm of extra expansion for every meter exceeding the maximum width. For example, a 10m wide room will require an extra 2mm of expansion distributed across the floor.

Where possible, expansion gaps must be left though doorways/archways and covered with T-sections to break up large areas of installation and a minimum expansion space of 15mm must be left around the perimeter and all vertical obstructions.



Distribute lengths, avoiding "H" patterns (as below) and other discernible patterns in adjacent runs. Stagger end joints at least three times the width of the boards, as product allows.

Figure 6.1 Avoid "H" Joints.

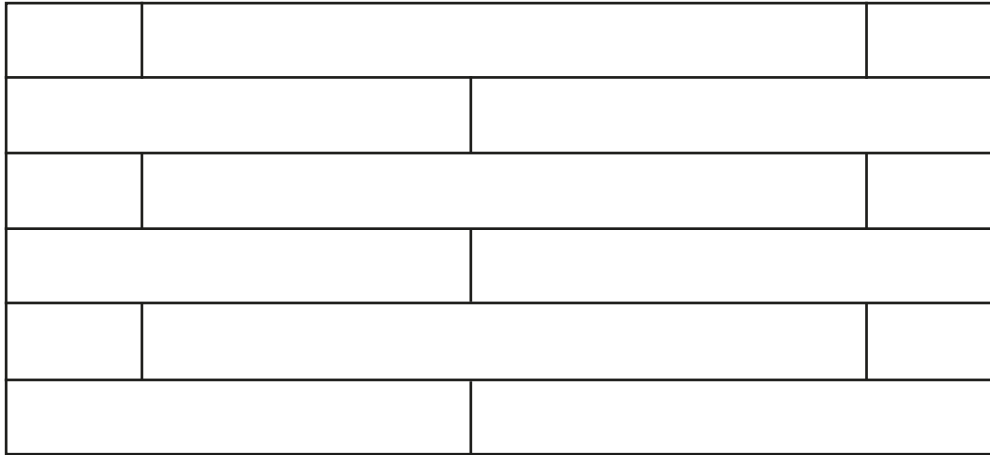
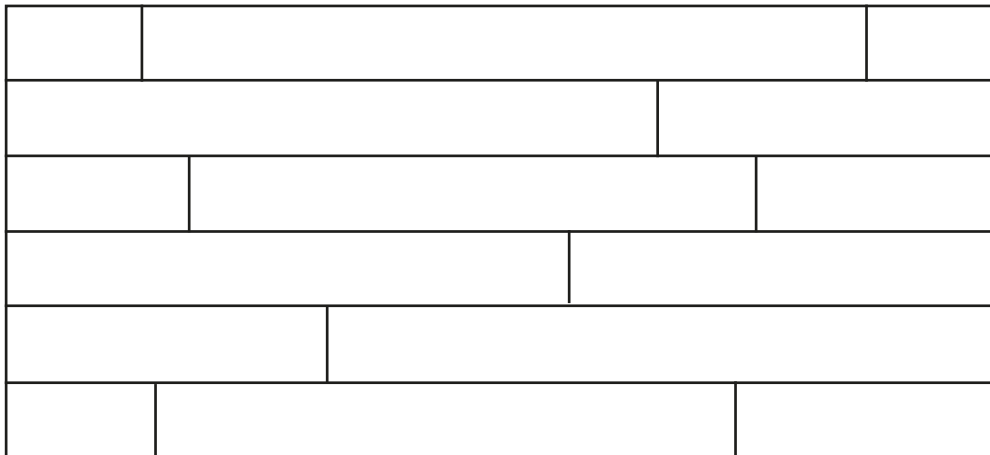

Figure 6.2 A better installation with staggered End Joints



For 2 and 3-layer engineered flooring there is frequently a bow within the board. This can be up to 25mm and therefore it is important to ensure that the first rows are laid with the boards being interlocked to around half of the length. This will ensure the boards lie flat and permit installation.



6.3.1 Glue Down Installation

Unless there is water fed under floor heating system installed apply 2 coats of Ted Todd Primerfast liquid damp proof membrane.

Tiles will require to be abraded and quartz crystals applied to the wet Ted Todd Primerfast before installation.

Snap a working line parallel to the starting wall, the width of the board, plus the tongue and recommended expansion space.

Install a starter board along the edge of the working line and begin installation.

Alternatively, lay one row of plank in Ted Todd MS Flex along the length of the working line and allow curing before starting the installation.

Please refer to Ted Todd MS Flex and Ted Todd Primerfast data sheets.

Spread the adhesive as instructed up to and along the working line. Use tensioners to maintain a tight floor.

6.3.2 Nail Down Installation

Only 20mm thick wood floors can be nailed.

This can be over any wood sub floor, refer to chapter 4 wood sub floor guidelines.

Our 20mm floors are ends matched, when installing over joists at 450mm centres there is no requirement to support head joints on a joist for normal domestic installations. If heavier point loading is expected all header joints should be supported.

If installing over solid sub flooring, planks must be laid at 45 or 90 degrees to sub floor boards or add a layer of minimum nominal 12mm Class1 plywood underlayment to the existing sub floor.

Always use Sisalkraft underlay with all nail down installations, overlapping the seams by min 100mm and returning up the wall.

Snap a working line parallel to the starting wall, allowing 15mm expansion space. Lay one row of plank along the entire length of the working line.

Top-nail and blind-nail the first row (hand-nail if necessary), using appropriate fasteners. Denser species may require pre-drilling. Each succeeding row should be blind-nailed wherever possible:

- a. Joists sub floors – Blind nail in each joist;
- b. Plank or Panel sub floors – Nail every 200 – 300mm.

During installation of flooring, push or gently tap boards flush to the previous row. Tap against the tongue using a knocking-block with a rubber mallet. Tapping the groove directly may damage the edge. To prevent damage to the finish, avoid tapping the face of the board.



6.3.3 Floating Plank Installation.

Do not install fixed items over floated engineered floors i.e. kitchen units or islands.

Do not float engineered floors where the room dimensions exceed 6m in width. Follow glue down installation methods.

All engineered plank floors can be floated over all acceptable sub floors see chapter 4 – 5.

Install an appropriate Ted Todd underlay, taping all seams with aluminium tape. Use the table below to help select the correct Ted Todd Underlay depending upon the installation and building type:

FACTOR	MEASUREMENT	BEST CHOICES OF TED TODD
Noise	dB Impact sound transmission. Broadly related to thickness.	Amphion(28dB) Bond 5mm (26dB) Blue (23dB) Olympia (23dB)
Moisture	Moisture barrier. Most Ted Todd Underlays have built-in moisture barriers.	All except Bond and Amphion. Can use the Moisture block foil
Levelling	Thickness can absorb small sub-floor surface variations)	Blue (5mm) Amphion (5mm) Bond (5mm), Olympia (3.6mm) Green (3.2mm)
Heat insulation	Tog value (want high, insulate from cold)	Blue (1.8), Bond 5mm (0.83)
UFH	Tog value. (Want low to aid heat transmission)	Green (Tog 0.1) Yellow (Tog 0.4)
Cost	£, Per Roll and per M2. Check latest Ted Todd price list.	Red, exceptional value £/m ² . Plus look at Bond total installation costs.
Ease of installation	Roll size, weight, packing, overlaps, cutting lines.	Blue (folded, with overlap) Bond (self-adhesive)
Compression / longevity	Density. How it performs and supports the T&G, effects of compression. Quality, weight.	Green (1000kg /m ²) Olympia (800kg /m ²)

Apply Ted Todd T&G Adhesive to top of tongue on lengths of boards and head joints ensuring the boards are clamped while the glue is left to cure.



CHAPTER 7 - SOLID PLANK FLOORING INSTALLATION

Do not install solid wood floors over under floor heating systems.

Do not install solid plank flooring in pre 1960's properties where the screed sub floor is in direct contact with the soil.

Solid wood floors can all be nailed down or nailed and glued. Solid wood floors up to 160mm width can be glued down using Ted Todd MS Flex adhesive.

Solid wood floors cannot be floated.

7.1 Site Checks

Before commencing installation ensure the requirements have been met for:

Jobsite Conditions (Chapter 1);

Moisture Testing (Chapter 2);

Acclimatisation (Chapter 3);

7.2 Acceptable Sub Floors

Concrete

Panel

Plank

Joists - 20mm products only.

7.3 Installation Guidelines.

Always check with the end-user that the correct product has been delivered and that the end user is happy with the grade and visual appearance of the floor. Open several packs at a time and mix the boards to ensure a good degree of board selection so that the installation is visually well-balanced.

Choose a starting wall according to the most aesthetically or architecturally important elements in the room, taking into consideration fireplaces, doors, cabinets and transitions, as well as the squareness of the room. The starting wall will often be the longest unbroken wall in the room.

Solid wood floors up to 160mm width can be glued directly to the sub floor. 20mm products can be nailed to timber sub floors.

For glue or nail installations where the maximum width exceeds 8m, extra expansion should be allowed in between the rows of the boards allowing 1mm of extra expansion for every meter exceeding the maximum width. For example a 10m wide room will require an extra

2mm of expansion distributed across the floor

Where possible expansion gaps must be left though doorways/archways and covered with T sections to break up large areas of installation and a minimum expansion space of 15mm must be left around the perimeter and all vertical obstructions.

Distribute lengths, avoiding "H" patterns and other discernible patterns in adjacent runs. Stagger end joints at least three times the width of the boards, as product allows.



7.3.1 Glue Down Installation

Apply 2 coats of Ted Todd Primerfast liquid damp proof membrane before all installations over concrete screeds

If the solid wood boards are over 160mm wide, it is necessary to nail and glue the floor. If the wide-board installation is over a concrete screed a ply sub floor will be required to be installed prior to installation (see 4.2 acceptable panel sub floors)

Tiled sub floors will require abrading and quartz crystals applied to an application of wet **Ted Todd Primerfast** before installation

Snap a working line parallel to the starting wall, the width of the board, plus the tongue and recommended expansion space.

Install a starter board along the edge of the working line and begin installation.

Alternatively, lay one row of plank in **Ted Todd MS Flex** along the length of the working line and allow to cure before starting the installation

Please refer to Ted Todd MS Flex and Ted Todd Primerfast data sheets

Spread the adhesive as instructed up to and along the working line. Use tensioners to maintain a tight floor.

7.3.2 Nail Down Installation

All nails and fastenings must comply with BS8201-2011.

Only 20mm thick solid wood floors can be nailed. If the boards are over 160mm wide, it is necessary to nail and glue the floor. If the installation is over a concrete screed a ply sub floor will be required to be installed prior to installation.

This can be over any wood sub floor, refer to chapter 4 wood sub floor guidelines

Our 20mm floor are ends matched, when installing over joists at 450mm centres there is no requirement to support head joints on a joist for normal domestic installations. If heavier point loading is expected all header joints should be supported.

If installing over solid sub flooring planks must be laid at 45 or 90 degrees to sub floor boards or add a layer of minimum nominal 12mm Class1 plywood underlayment to the existing sub floor

Always use Sisalkraft underlay with all nail down installations. Overlapping the seams by min 100mm and returning up the wall

Snap a working line parallel to the starting wall, allowing 15mm expansion space. Lay one row of plank along the entire length of the working line.

Top-nail and blind-nail the first row (hand-nail if necessary), using appropriate fasteners. Denser species may require pre-drilling. Each succeeding row should be blind-nailed wherever possible.



- a. Joists sub floors – Blind nail in each joist
- b. Plank or Panel sub floors – Nail every 200 – 300mm

During installation of flooring pieces, push or gently tap boards flush to the previous row. Tap against the tongue; tapping the groove may damage the edge. To prevent damage to the finish, avoid tapping the face of the board with a rubber mallet.

For wide rooms in excess of 6 meters use the following installation method:

Find the centre of your room, measuring off the two longest walls, and snap a line down the centre of that room.

Install a starter board on the line. Fasten the starter board to the floor using wood screws. Nail the first row of wood flooring against the starter board, being careful not to move the

starter board when nailing. The groove of the flooring should be against the starter board.

Drill and hand-nail the first three rows through the tongue. **DO NOT USE TOP NAILS.**

Use a blind nailer to install the remaining rows of wood flooring. Use the nailing practices described earlier in the chapter.

After installing in one direction, remove the starter board and start rows going in the opposite direction.

Install a false tongue in the groove of the board that was against the straight- edge. Put wood glue down the entire length of the groove before installing the tongue.

Install the remaining rows in the opposite direction. Use the nailing practices described earlier in the chapter.



CHAPTER 8 - UNDER FLOOR HEATING (UFH)

8.1 General Guidelines

Thermal resistance of wood varies with the species but is in the order of 0.13m² K/W. Wood naturally reduces heat transfer through the whole floor construction and thus wood flooring should only be considered over an UFH installation with full prior consultation with the heating engineer.

Please also note that most Ted Todd engineered floors are supplied with a moisture content (MC) of between 8% - 10%. After a period of time under an UFH installation the MC of the wood may drop to 6%-8% or lower. This could cause some shrinkage in the floor boards. Similarly, if the UFH system is switched off after installation (such as in the summer) the M/C of the floorboards may rise again causing some width expansion. For this reason, the MC of the wood floor must be carefully checked before installation and if necessary, extra acclimatisation should take place. Similarly, allowance should be considered for some expansion of the wood in case the heating system is switched off and the site's humidity rises again.

All of our engineered floors are suitable for installations with UFH systems. You must check with the manufacturer of the UFH system to ensure that the system can be properly controlled to ensure the maximum temperature of the timber floor (at any point) will not exceed 27°C.

All installations of Ted Todd wood floors over UFH systems must be accompanied by the installation of the Ted Todd Fidbox monitoring system allowing the temperature and humidity of the wood floor and sub-floor to be monitored and recorded.

It is important that you set the UFH system to make sure that it cannot in any circumstance cause a floor surface temperature that exceeds 27°C. The Ted Todd Fidbox system is essential and this can also be backed up by use of an infrared heat monitor. These are inexpensive and will allow you to calibrate the maximum running temperature of your heating system to a floor surface temperature of 27°C.

For water systems this is easily achieved by adjusting the flow-control valves regulator to a maximum water temperature that is commensurate with a floor temperature of 27°C.

For electric systems you will also need to set up the system so it is impossible for the floor temperature to exceed 27°C

Please note that the 27°C is across the whole floor and it is common for poorly installed systems to have hot spots. The calibration of both water and electric systems needs to be measured against the hottest areas in the floor. The sub-floor construction must have a heat-distributing layer that gives an even temperature over the entire surface of the floor area, in order to prevent high temperatures in certain spots.

Please also note that under floor heating systems are designed to operate as a "slow" heating source. The appeal is that they omit an even level of heat over a long period of time. The only circumstances within most properly insulated homes that a temperature of 22°C cannot be achieved with a floor temperature of 27°C is when the 22°C is demanded too quickly. In this respect if you use an under floor heating system like a conventional radiator, you will damage the floor as the short term temperature boost will cause excessive temperature in the floor



Please note that room temperature settings are NOT floor temperature settings. The UFH heating system must have its own control system at the floor level to prevent overheating.

The temperature of the floor only needs to exceed 27°C for a short period of time to damage the floor.

Early signs that the heating system is running too hot include: colour fade in the floor's natural tone, small longitudinal splits along the centre and ends of a plank. (This is normally prevalent around knots). If corrective action is not put in place quickly the hardwood layer in your floor will start to shrink. When this happens the hardwood layer will curl up at the edges. In extreme circumstances the dried out hardwood layer will move to such a degree that it becomes loose and will start to delaminate from the backing layer. When dried out hardwood layers become loose they will normally need to be replaced, however in some circumstances the wear layer can be glued back into place. (The additional use of a micro nail gun will hold the boards in place whilst the glue dries). Replacing wear layers is a professional undertaking and requires the removal of either the entire plank from the floor or in some circumstances the removal of the hardwood wear layer. This can sometimes be undertaken without damaging the finish on the floor. However, if the floor does not have bevels between each component, the floor will need to be refinished. The re-finish could be straight forward and only involve a light sand to the existing finish and then the application of additional coats of finish. Alternatively, in some circumstances the floor will need sanding back to bare wood prior to re-finishing.

Please note that all Ted Todd engineered wood floors are tested for adhesive bond strength. The bond performance between the hardwood layer and core meets all European standards. Wood floors that fail over under floor heating fail due to shrinkage in the hardwood layer of the board and not due to poor adhesion.

Where possible we recommend that all floors are glued to the sub floor with Ted Todd MS Flex adhesive but this will depend on the system and sub floor you have chosen. Please ensure the sub floor is rated to allow direct gluing of timber floors.

The ambient humidity and temperature should always be maintained.

Do not lay rugs / large items that will trap the heat over floors with under floor heating systems as this can cause excessive drying of the timber.

Some electric under floor heating systems are not suitable for installations with timber flooring, check with the manufacturer that the system will adhere to the above criteria.

8.2 Water Fed Systems

The UFH installer must ensure that all services running beneath the floor have been fully tested and commissioned before laying starts.

Once the screed is dry as specified in Chapter 2 - Moisture Testing, and prior to installation follow heat up procedure as below.

Please note that this is to check that the system is working properly and to dry out the installation screed. Under no circumstances should the system be run at these high temperatures once the wood flooring is installed.



- Day 1 - 20°C
- Day 2 - 30°C
- Day 3 - 40°C
- Day 4 - 50°C or the maximum planned operating temperature and maintained constantly for 7 days
- Day 12 - 40°C
- Day 13 - 30°C
- Day 14 - 30°C
- Day 15 – Switch off heating system.

Allow 4 days before a final moisture reading is taken.

If more than 7 days elapse between the last cooling down day and the start of laying the flooring, the UFH system should be run at minimum operating temperature for 2 days. The system should then be switched off for at least 4 days before a further moisture check is carried out prior to laying.

Once this has been completed and moisture checks agree with recommendations and your sub floor is suitable for glue down installation follow guidelines in Chapter 6.3.1 Glue Down Installation. If your sub floor is not suitable for glue down installation, follow guidelines in Chapter 6.3.3 Floating Installation.

8.3 Electric Systems

Some electric UFH systems are not suitable for installations with timber flooring, check with the manufacturer that the system will adhere to the general guidelines.

If the system is suitable follow guidelines in Chapter 6.3.3 Floating Installation.

8.4 Heating Systems Over Suspended Floors

For installations where the UFH is suspended in joists or an overlay system, consult your supplier of the heating system to ensure it is rated for use with engineered wood floors and follow their installation instructions.

Always follow our general guidelines for UFH and check joist spacing as per Chapter 4 - Acceptable Sub Floors.

8.5 Underfloor heating in just part of a continual floor area.

If the UFH is to be installed in just part of a continuous floor area, (e.g. in an open lounge-diner area with UFH just in the lounge area) it is important that the floor area is separated.

There needs to be a break between the heated area and the non-heated area. The use of a Ted Todd "T" section is ideal for this purpose.

This is to avoid any potential problems with differential expansion or shrinkage between the two areas.



CHAPTER 9 - REACTION TO FIRE

All Ted Todd wood floors, with thickness 8mm or above, can be classified at minimum, according to BS EN 14342-2013, as Dfl-S1 when installed without an air gap underneath.

Most Ted Todd 20mm thickness 2-ply Oak floors can be classified, according to BS EN 14342-2013, as Cfl-S1 when installed with or without an air gap underneath.

Specification sheets, including the fire classification, for every Ted Todd floor are available upon request.

Please check the design specification for the project where the wood floor is being installed to ensure that the wood floor and the installation method does comply with the design spec.



APPENDIX A - SAFETY GUIDELINES

Safety first.

Safety on the job is the foremost concern for contractors, because accidents with power tools can be critical, even disabling or deadly. No amount of experience or expertise exempts you from safety risks inherent in using the tools required to install hardwood floors. The good news is that these risks are easily managed. Start with these general guidelines:

- Never work under the influence of alcohol, drugs or medication;
- Work with others nearby, if possible;
- Do not work on a cluttered floor;
- Use proper lighting and ventilation;
- Make sure that the electrical power and wiring at the jobsite is sufficient to operate all machines safely;
- Know your insurance company's policy on coverage related to accidents or jobsite situations;
- Wear proper work clothing and shoes. Do not wear loose clothing that could get caught in a machine;
- Wear approved hearing protection and safety glasses, as well as dust and fume respirators, knee protection and gloves;
- Have an approved first-aid kit on the job site;
- Read and fully understand the owner's manuals that are supplied with the equipment;
- Use tools only as intended;
- Use all tool and machine safety guards;
- Turn off and unplug electrical tools and machines when making adjustments and attaching accessories;
- Turn off all sources of ignition when using flammables;
- Use fault circuit breakers on electric tools to avoid electric shock;
- Carry and read MSDS (Material Safety Data Sheets) for all products.



APPENDIX B - EQUILIBRIUM MOISTURE CONTENT OF WOOD SPECIES AT VARIOUS TEMPERATURES AND RELATIVE HUMIDITY READINGS.

Wood Flooring Has a Comfort Level Too: Wood flooring will perform best when the interior environment is controlled to stay within a relative humidity range of 40% to 60 % and a temperature range of 15 to 26 degrees centigrade. Fortunately, that’s about the same comfort range most humans enjoy. The charts below indicate the equilibrium moisture content of European Oak species of wood under various temperature and humidity conditions.

BS8201 suggests a range of average moisture contents to suit varying conditions:

- Unheated - 15% to 19% |
- Intermittent Heating - 10% to 14%
- Continuous Heating - 9% to 11%
- Under floor Heating – 6% to 8%

AMBIENT TEMPERATURE					
Relative Humidity	15°C	20°C	25°C	30°C	35°C
20%	6	5.5	5.5	5.5	5
25%	7	7	6.6	6	6
30%	8	7.5	7	7	6.5
35%	9	8.5	8	7.5	7.5
40%	9.5	9.5	9	8.5	8
45%	10	10	9.5	9.5	9
50%	11	11	10.5	10	10
55%	12	12	11.5	11	10.5
60%	13	13	12.5	12	11.5
65%	14.5	14	13.5	13	12.5
70%	15.5	15	14.5	14	14
75%	16.5	16	16	15.5	15
80%	18	18	17.5	17	16.5

Coefficients of Change: How Moisture Affects Wood Flooring.

At 20°C a relative humidity of 25 % gives an EMC of 7 %, and a relative humidity of 75 % gives an EMC of 16 %. A 50 % variance in relative humidity produces an EMC change of 20 %. How that affects wood flooring depends on which species is being used. However, let’s say the width variation is just 1.5mm for a 57mm strip. That’s a full 25mm over 16 strips in a floor. Over the width of a 6 meter wide floor, that amounts to more than 75mm of total expansion or contraction.

Protective coatings cannot prevent wood from gaining or losing moisture; they merely slow the process. Installers need to take those expected dimensional variations into account when installing the wood flooring.



APPENDIX C - PROPER INSTALLATION BY CALCULATING COEFFICIENTS OF CHANGE.

Proper installation depends not only on the moisture content of the wood and the environmental conditions at the time of installation, but also on expected seasonal changes in temperature and humidity at that location — changes that may cause the wood flooring to gain or lose moisture content over time. Such changes are likely to occur even if the building occupants maintain interior environmental conditions through use of a heating and/or air-conditioning system.

For example, if a wood flooring installation takes place when relative humidity is high, the wood flooring will lose moisture content and therefore shrink during low-humidity seasons. In that case, install the flooring tightly enough to minimize the expected separations that will occur as the boards shrink during dry seasons. Conversely, if an installation takes place when humidity conditions are low, it's likely that the wood flooring will gain moisture and expand during humid seasons. In those cases, incorporate additional expansion space through use of spacers.

How much expansion space to leave will depend on the expected changes in moisture content of the wood flooring, and that will depend on the dimensional change coefficient of the species being installed and the width of the flooring.

Predicting temperature and humidity changes: Installers will generally have a good idea as to the prevailing conditions within their installation areas and these should be taken into account when making any decisions concerning the acclimatisation of the flooring and calculation of the movement in use.

Calculating dimensional change:

Different species of wood flooring exhibit different coefficients of change and, therefore, have different rates of dimensional stability. That is, some woods are more prone to expansion and shrinkage than others. The British Wood Flooring Association's Technical Publication No. A200: Wood Species Used in Wood Flooring lists dimensional change coefficients for many common wood species used in wood flooring.

To calculate the expected dimensional change in wood flooring, you will need to determine the current moisture content of the wood flooring, using a moisture meter. Then calculate the expected change in moisture content, using the equilibrium moisture content chart above and the climate data for the location in which then flooring is to be installed. Finally, you will need to know the dimensional change coefficient of the species to be installed.

With that information in hand, you will be able to perform a simple calculation that will tell how much the wood flooring is likely to expand or shrink. That calculation multiplies the change in moisture content by the change coefficient, multiplied by the width of the flooring boards.

Change coefficient x moisture content change x board width = dimensional change

For example, let's say that climate data for the location indicates that the maximum moisture content for the wood flooring will be 10.5 % (relative humidity of 50 % and temperature of 25°C). Let's also say that the wood flooring currently has a moisture content reading of 7.5%. That means the wood is likely to experience



a change in moisture content of 3 % (10.5% - 7.5%) from dry season to humid season. In the example, let's say that the wood flooring to be installed is

127mm plank red oak. Red oak has a change coefficient of .00369. We now have the data we need:

Change coefficient = .00369 Moisture content change = 3% Board width = 127mm

The following calculation would apply: $.00369 \times 3 \times 127 = 1.4\text{mm}$

In other words, for every 3-percentage-point increase in moisture content, a 127mm board will expand by more than 1.4mm. Over 10 boards, that will equal over 14mm of expansion — something the installer will need to take into account, although in actual practice the installation and fastening process will tend to restrain board movement somewhat.



APPENDIX D - TRAMMEL POINT METHOD

Trammel Points.

Trammel points, which are used to scribe a circle or radius, consist of two points mounted on a beam - typically a piece of wood - and designed to slide along the beam to increase or decrease the radius. Typically, one of the points is a pencil or pen, while the other is usually a metal point used to anchor the centre of the circle or the radius. The size of the radius can be adjusted by sliding the marking point along the beam to the desired length and locking it into position.

Fig D.1

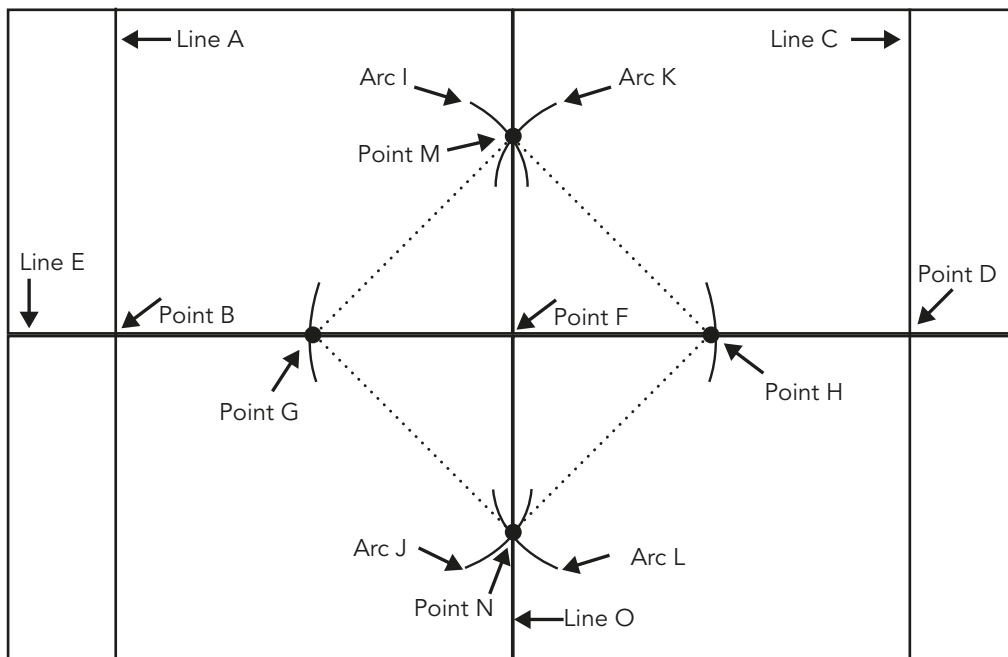

Trammel Point Method for Squaring a Room and Finding the Centre.

See Figure D.1

1. Measure the width of the room from top to bottom left of Centre (Line A).
2. Find the Centre of Line A and mark it (Point B).
3. Measure the width of the room from top to bottom right of Centre (Line C).
4. Find the Centre of Line C and mark it (Point D).
5. Adjust for any difference in Centre between Point B & Point D. For example, if Point B is one inch different than Point D, divide the difference by two to establish the new Centre point of Line A
6. Snap a line the length of the room from Point B through Point D. This is now Line E.
7. Find the Centre point of Line E and mark it Point F.
8. From Point F, use trammel point at fixed position on flat board to mark through Line E left of Centre, and mark it Point G.



9. From Point F, use trammel point at the same fixed position on flat board to mark through Line E
right of Centre, and mark it Point H.
10. From Point G, use trammel point at a fixed position on flat board draw arc above Line E. Mark this Arc I.
11. From Point G, use trammel point at the same fixed position on flat board draw arc below Line E.
Mark this Arc J.
12. From Point H, use trammel point at the same fixed position on flat board draw arc above Line E.
Mark this Arc K.
13. From point H, use trammel point at the same fixed position on flat board draw arc below Line E.
Mark this Arc L.
14. Where Arc I and Arc K intersect, mark it Point M.
15. Where Arc J and Arc L intersect, mark it Point N.
16. Snap a line from Point M through Point N, and mark it Line O.
17. Where Line O intersects Line E is the Centre of the room. Line E and Line O also form a 90-degree angle.



APPENDIX E - SOUND CONTROL

Covered by Local Building Regulations, E sound.

When installing wood floors (hard surface flooring) in multi-family dwellings it is necessary to take into consideration the contents of the Sound Control Schedule E of your Local Building Regulations which may vary from region to region.

Installation.

A basic key to peak performance is to avoid hard surface transference points. This would mean that the floor should not come in direct contact with the wall or any moulding such as skirting or architrave. A small gap should be left between the moulding and the floor as well as the floor and the wall. Leaving a gap would prevent sound from traveling across the floor to the wall or moulding and down behind the wall where there is no sound control.

Nails are also considered a hard surface transference point. When installing a nail down wood floor nails should not penetrate through the floor and into the sound control material and sub floor below. Doing so would greatly diminish the performance of the sound control material.

Sound Control Product Types

There are a wide variety of materials that are marketed for their noise control properties. Some are systems, and others are specific materials. Noise transfer from floor to ceiling is dependent upon the entire floor-ceiling assembly.

Variables, such as type of floor (i.e. wood or ceramic, laminate, marble), concrete thickness, with or without suspended ceiling, wood frame structure can greatly affect the Sound Control performance of the installation.

For wood floor installation in areas where Sound Control is important, always use Ted Todd Underlays on floating floor installations.

The most effective sound reduction products are as follows:

PRODUCT (See current price list for full range)	DB IMPACT SOUND REDUCTION	DESCRIPTION	ITEM CODE
Ted Todd Universal Green 3.0mm Underlay.	20dB	A high-tech acoustic underlay with vapour barrier. For UFH installations, Tog value 0.1	5m2 roll ACCUND03
Ted Todd Olympia 3.6mm rubber underlay	23dB	Multi-purpose, high load-bearing noise reducing underlay with vapour barrier.	15.07m2 roll ACCUND15
Ted Todd Amphion 5.0mm rubber sponge underlay	28dB	5.0mm rubber sponge underlay for use when high sound reduction is needed.	15.07m2 roll ACCUND16
Ted Todd Universal Bond 5mm high-grab self-adhesive underlay	26dB	Self-adhesive backed, recycled rubber-crumble underlay ideal for access flooring applications.	10m2 roll ACCUND13



APPENDIX F - MOULDINGS USED WITH HARDWOOD FLOORS

Wood floors require expansion space at the wall and all vertical obstructions. Mouldings are used to cover the expansion area, to hide cut ends, to adjust height differences or transitions between floors and to aesthetically finish the area.

- **REDUCER** -- supplied for 15 and 20mm thick floors; used to make transition in thickness from wood floor down to thinner surface, generally through door openings.

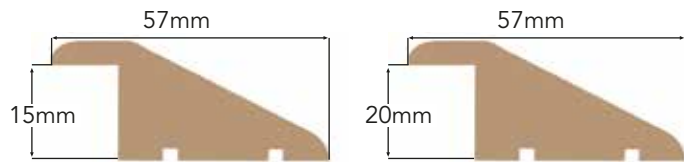

- **T SECTION** - supplied for 15 and 20mm thick floors; used to make the transition at doorways, between interior rooms from one hard surface floor to another at equal heights.

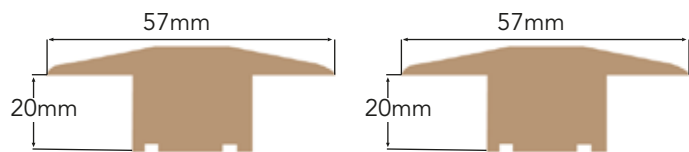

- **L SECTION** - supplied for 15 and 20mm thick floors; used to cover expansion space in perimeter areas such as stone, brick wall and hearths as well as floor to ceiling glass and sliding doors, may also be used against existing door thresholds.

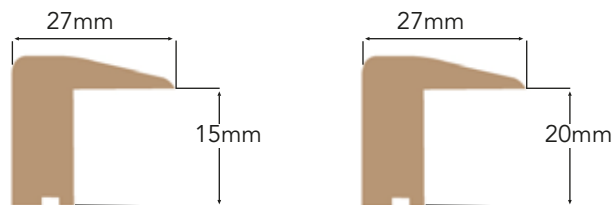

- **STAIR NOSING** - Thickness is the same as the flooring and supplied in 15 and 20mm. This profile is used to create a finished edge on a top step, around stairwell or a sunken living room, etc.

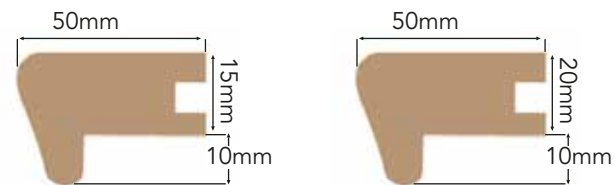

- **SCOTIA** - 19 x 19mm profile, to be used to cover expansion space where skirting is in place and not being removed prior to installation of flooring.

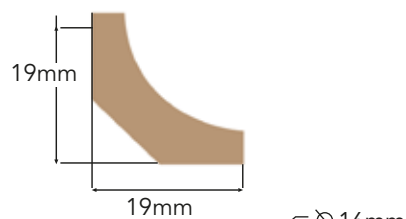

- **PIPE FERRULE** - 16mm internal diameter pipe cover to conceal expansion space created around radiator pipes

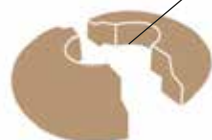

Oak profiles can be colour-matched to complement all of Ted Todd floors on request.



APPENDIX G - JOBSITE CHECKLIST

(Also see Chapter 1, Jobsite Conditions)

One primary rule will eliminate many potential problems caused by jobsite conditions: Wood flooring should be one of the last jobs completed on any construction project. In particular, the jobsite should be enclosed and climate-controlled before wood flooring is delivered or installed. In addition, other trades working on the jobsite can damage the wood flooring installation; so many problems can be minimized by limiting the amount of traffic at the jobsite after the wood flooring is installed.

Certainly, the jobsite should be carefully evaluated for potential problems before installation begins, but a thorough site evaluation should also be done even before wood flooring is delivered to the jobsite.

The re-printable Jobsite Checklist on the following pages can be used on the jobsite.



JOB SITE CHECKLIST

Customer Name..... Date / /

Address.....

.....

.....Postcode.....

Contact Home..... Mobile.....

Site Address (if different from above).....

.....

.....Postcode.....

PRODUCT INFORMATION

- | | | | |
|-------------------------------------|--|---------------------------------|-------------------------------------|
| <input type="checkbox"/> Solid | <input type="checkbox"/> Micro Bevel | <input type="checkbox"/> Nature | <input type="checkbox"/> Finished |
| <input type="checkbox"/> Engineered | <input type="checkbox"/> Square Shoulder | <input type="checkbox"/> Prime | <input type="checkbox"/> Unfinished |

Product Description.....

WidthThicknessFinish.....

Profiles Matched to floor Supplied Unfinished

T Section 0.96m x 2.35m x

Reducer 0.96m x 2.35m x

L Section 0.96m x 2.35m x

Scotia 2.35m x

Pipe Ferrules x



PROPERTY SURVEY

Has the property previously encountered any moisture problems?

.....
.....

Is installation below or above ground?.....

If sub floor is more than 75mm below ground level this is considered below ground and only engineered boards are suitable.

Type of sub floor

Joists Panels over Joists Existing Plank Screed
 Tiles Other

Work required for sub floor preparation including vapour retarders

.....
.....
.....

Average moisture content of sub floor.....

Relative Humidity of room/s

Temperature of room/s.....

Any actions required after visual inspection of property

.....
.....
.....

Cavity Floors (if present)

Depth of crawl space to under side of floorboards?.....

Are air bricks clear of obstruction and provide adequate ventilation?.....

Room cleared of furniture prior to installation Yes No



INSTALLATION

Type of Installation

Float

Nail

Glue

Work required for sub floor preparation including vapour retarders

.....
.....
.....

CHECKS ON DELIVERY OF PRODUCT

Has the correct flooring been delivered and is the end-user happy with the delivery and the visual grading?.....

Product moisture content on delivery.....

Relative Humidity of room/s

Temperature of room/s.....

(Compare to reading taken on survey)

Maintenance products provided with floor Yes / No



INSTALLATION PLAN

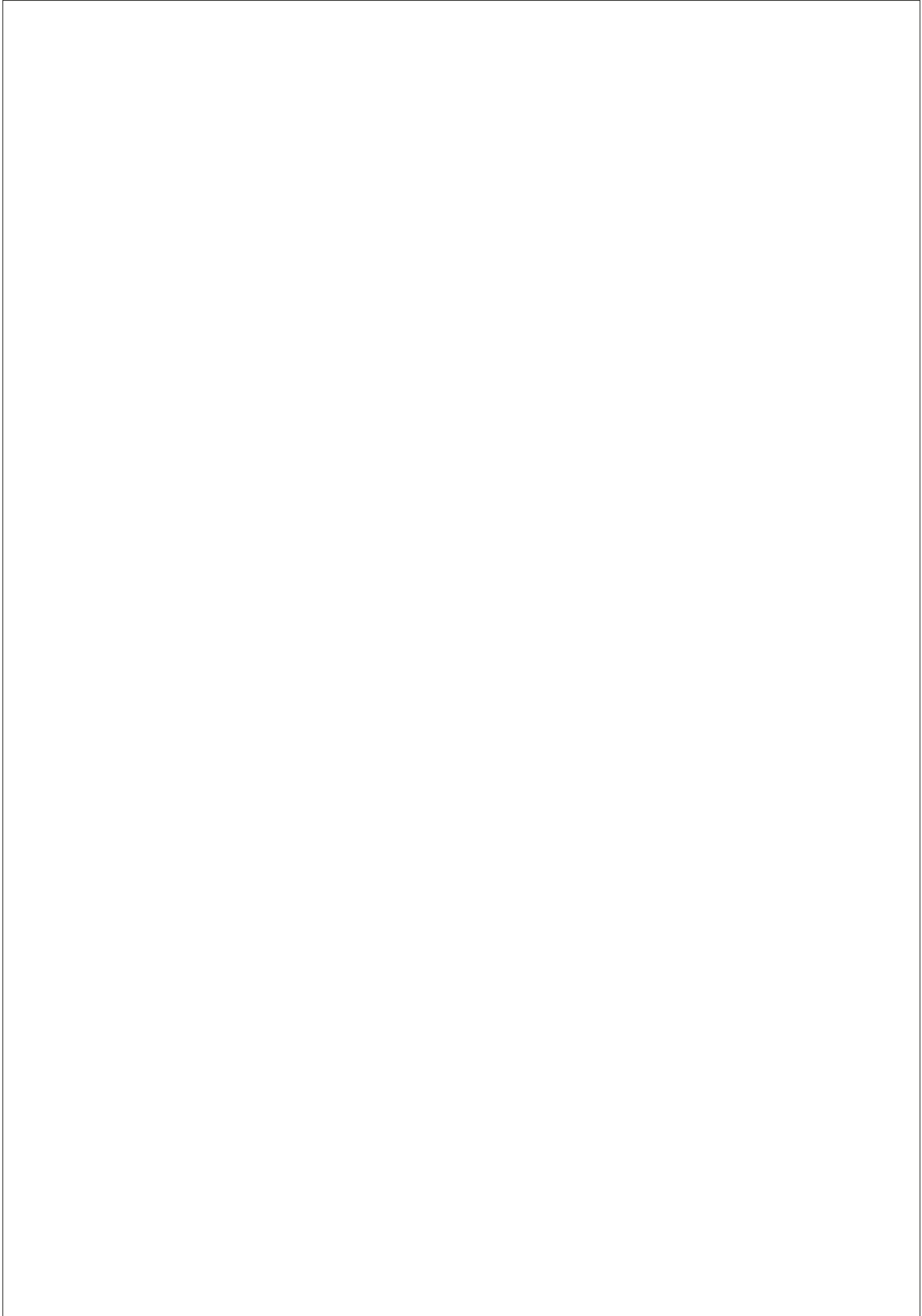

APPENDIX H - FORMALDEHYDE RELEASE

Some resins and coating used in the production process of wood flooring may contain formaldehyde. Where this is present these products have been produced and tested in accordance with British Standard BS EN 14342:2005 for solid wood flooring and BS EN

13986 for wood based panels and are class E1.



APPENDIX I - CARE AND MAINTENANCE. TED TODD FLOOR CARE SYSTEMS.

I.1 Lacquered, Hardened oil (UV Oiled) and Oilwood Traffic finishes.

Care System 1.

Please check that a Ted Todd Floor Care System 1 kit has been ordered and delivered.

It is firstly very important to keep the floor regularly swept or vacuumed to remove dust and debris from the floor, as this can be abrasive on the finish and will dramatically reduce the life of your floor.

For normal residential / light contract use:

Regularly clean your floor using FLOOR CARE EASY CLEAN. This will clean and nourish your floor.

Over a period of time your floor may start to look tired or dull, at this stage apply a coat of FLOOR CARE POLISH after a clean with FLOOR CARE EASY CLEAN.

For contract use or areas that require more protection.

Immediately after installation of the floor, clean with FLOOR CARE EASY CLEAN and apply a coat of FLOOR CARE INTENSIVE MAINTENANCE POLISH.

You can reapply FLOOR CARE INTENSIVE MAINTENANCE POLISH after cleaning with FLOOR CARE EASY CLEAN when your floor looks tired or dull.

Over time residues of the FLOOR CARE INTENSIVE MAINTENANCE POLISH will build up on your floor, remove the residues with FLOOR CARE POLISH REMOVER and re-apply a fresh coat of FLOOR CARE INTENSIVE MAINTENANCE POLISH for a fresh start.

You should also note that you should NOT wait until the floor is worn down to raw wood before you re-lacquer. In high wear areas it is advisable to re-coat before this happens as you will only need to gently abrade the existing lacquer and NOT remove all of it before additional coats of lacquer are applied.

Regular maintenance will prolong the life of the finish on your floor. Please see data sheets for all products prior to use.



I.2 Natural oils, Hardwax Oils and Restoration Oil finishes.

Care System 2.

Please check that the correct Ted Todd Care System 2 kit has been ordered and delivered.

It is firstly very important to keep the floor swept or vacuumed to remove dust and debris from the floor, as this can be abrasive on the finish and will dramatically reduce the life of your floor.

Regular cleaning with FLOOR CARE SOFT CLEAN will clean and nourish your floor.

If your floor is heavily soiled clean with FLOOR CARE INTENSIVE CLEAN to remove engrained dirt.

To refresh a worn or dry looking oiled floor after cleaning with FLOOR CARE INTENSIVE CLEAN use FLOOR CARE OIL REPLENISH maintenance oil to restore the finish and bring life back to your floor. This is very easy to apply with either a lint free cloth /roller or paint brush.

Regular maintenance will prolong the life of the finish on your floor.

For white coloured Oiled floors, please use the Ted Todd White Oiled Cleaning kit and Ted Todd Soft Clean-White.

Please see data sheets for all products prior to using.



I.3 Cleaning Schedule for Contract Flooring Installations.

I.3.1 Care System 1 for UV Lacquer, Hardened Oil, UV Oil and Oil Wood Traffic.

FREQUENCY	PROCESS	PRODUCT	STOCK CODE
After installation and before handover:	Hoover & Clean	Floor Care Easy Clean	1 ltr ACCM&R03 5 ltr ACCM&R10
	Protect	Floor Care Intensive Maintenance Polish	Matt: 1 ltr ACCM&R05 5 ltr ACCM&R12 Gloss: 1 ltr ACCM&R31 5 ltr ACCM&R32
Weekly, or as required	Clean	Floor care Easy Clean	1 ltr ACCM&R03 5 ltr ACCM&R10
Monthly	Clean	Floor Care Easy Clean	1 ltr ACCM&R03 5 ltr ACCM&R10
	Protect	Floor Care Intensive Maintenance Polish	Matt: 1 ltr ACCM&R05 5 ltr ACCM&R12 Gloss: 1 ltr ACCM&R31 5 ltr ACCM&R32
Yearly, or as required	Remove built-up polish	Floor Care Polish Remover	1 ltr ACCM&R06
	Clean	Floor Care Easy Clean	1 ltr ACCM&R03 5 ltr ACCM&R10
	Protect	Floor Care Intensive Maintenance Polish	Matt: 1 ltr ACCM&R05 5 ltr ACCM&R12 Gloss: 1 ltr ACCM&R31 5 ltr ACCM&R32



I.3.2 Care System 2. Natural Oil, Hard Wax Oils and Restoration Oil finishes.

FREQUENCY	PROCESS	PRODUCT	STOCK CODE
After installation and before handover:	Hoover & Clean	Floor Care Soft Clean	1 ltr ACCM&R07 5 ltr ACCM&R13
	Clean - white oiled	Floor Care Soft Clean White	1 ltr ACCM&R18
Weekly, or as required	Clean	Floor Care Soft Clean	1 ltr ACCM&R07 5 ltr ACCM&R13
	Clean - white oiled	Floor Care Soft Clean White	1 ltr ACCM&R18
Bi-Yearly or as required	Deep Clean	Floor Care Intensive Clean	1 ltr ACCM&R09 5 ltr ACCM&R15
	Protect / Replenish	Floor Care Oil Replenish	1 ltr ACCM&R08 5 ltr ACCM&R14



I.4 Cleaning Schedule for Residential Flooring Installations

I.4.1 Care System 1 for Lacquers / Hardened oils/ UV Oils / Oil Wood Traffic

FREQUENCY	PROCESS	PRODUCT	STOCK CODE
After installation and before handover	Hoover & Clean	Floor Care Easy Clean	1 ltr ACCM&R03
			5 ltr ACCM&R10
Weekly, or as required	Clean	Floor care Easy Clean	1 ltr ACCM&R03
			5 ltr ACCM&R10
Bi-Yearly or as required	Clean	Floor Care Easy Clean	1 ltr ACCM&R03 5 ltr ACCM&R10
	Protect	Floor Care Polish	1 ltr ACCM&R04 5 ltr ACCM&R11

I.4.2 Care System 2. Natural Oil, Hard Wax Oils and Restoration Oil finishes.

FREQUENCY	PROCESS	PRODUCT	STOCK CODE
After installation and before handover:	Hoover & Clean	Floor Care Soft Clean	1 ltr ACCM&R07
			5 ltr ACCM&R13
Weekly, or as required	Clean - white oiled	Floor Care Soft Clean White	1 ltr ACCM&R18
	Clean	Floor Care Soft Clean	1 ltr ACCM&R07 5 ltr ACCM&R13
Bi-Yearly or as required	Clean - white oiled	Floor Care Soft Clean White	1 ltr ACCM&R18
	Deep Clean	Floor Care Intensive Clean	1 ltr ACCM&R09 5 ltr ACCM&R15
Bi-Yearly or as required	Protect / Replenish	Floor Care Oil Replenish	1 ltr ACCM&R08
			5 ltr ACCM&R14



APPENDIX J – STOCK CODES OF KEY ESSENTIAL PRODUCTS

INSTALLATION PRODUCTS	DESCRIPTION	ITEM CODES
Sub-floor primer.	Ted Todd Primerfast. Solvent-free DPM	6kg ACCSUB01 12kg ACCSUB02
Bitumen Coated Builders Paper.	Ted Todd Sisalkraft. Damp and draft exclusion barrier for nail-down installations over joists or battens.	25m2 ACCUND01 Roll
Underlay for floating floors. (See brochure for full list)	Ted Todd 2mm Red. Underlay with moisture barrier. Ted Todd 3mm Green. Underlay with moisture barrier. Ted Todd Universal Bond Self Adhesive Underlay 3mm.	15m2 roll ACCUND11 5m2 roll ACCUND03 15m2 roll ACCUND12
Aluminium Tape	Ted Todd Alu Tape. Self adhesive tape to seal underlay vapour barriers.	25m roll ACCUND06
Adhesive for gluing down solid and engineered floors and parquet.	Ted Todd MS Flex. MS Technology single component adhesive.	10kg tub ACCADH01 600g ACCADH02
T&G Adhesive.	Ted Todd T&G Adhesive. For gluing the T&G when floating engineered floors	500ml ACCADH03
In-Floor monitoring system.	Ted Todd Fidbox. In-Floor monitoring system recording temperature and humidity under the wood floor. Essential in UFH installations.	1 box HD002
CARE PRODUCTS	DESCRIPTION	ITEM CODES
System 1, Care Kit.	Ted Todd Care System 1. Care kit for Lacquered, UV oil, Hardened Oil finished floors.	Kit box ACCM&R01
System 1, Cleaner.	Ted Todd Floor Care Easy Clean. Neutral detergent for regular cleaning.	1 ltr ACCM&R03 5 ltr ACCM&R10
System 1, Polish.	Ted Todd Floor Care Polish. A blend of industrial waxes for occasional polishing of lacquered floors.	1 ltr ACCM&R04 5 ltr ACCM&R11
System 1, Deep Clean.	Ted Todd Floor Care Polish Remover. Removes old layers of polish from varnished wood floors.	1 ltr ACCM&R06
System 1, Replenish.	Ted Todd Intensive Maintenance polish Matt. A hardwearing polish for refreshing worn and tired matt finished lacquered floors.	1 ltr Matt ACCM&R05 5 ltr Matt ACCM&R12
System 1, Replenish.	Ted Todd Intensive Maintenance polish Gloss. A hardwearing polish for refreshing worn and tired gloss finished lacquered floors.	1 ltr Gloss ACCM&R31 5 ltr Gloss ACCM&R32
CARE PRODUCTS	DESCRIPTION	ITEM CODES
System 2 Care Kit.	Ted Todd Care System 2. Care Kit for Natural Oil, Restoration Oil and Hardwax oiled floors.	Kit Box ACCM&R02
System 2, Cleaner.	Ted Todd Floor Care Soft Clean. A nourishing detergent for regular cleaning of oiled floors.	1 ltr ACCM&R07 5 ltr ACCM&R13
System 2, Deep Clean.	Ted Todd Floor Care Intensive Clean. An intensive cleaner to remove engrained dirt.	1 ltr ACCM&R09 5 ltr ACCM&R15
System 2, Replenish.	Ted Todd Floor Care Oil Replenish. A maintenance oil for refreshing worn and tired oiled floors and after using Intensive Clean.	1 ltr ACCM&R08 5 ltr ACCM&R14



Tel: 01925 283 000

email: hello@tedtodd.co.uk

Ted Todd manufacturing HQ & Cheshire design centre, 18 Chesford Grange, Cheshire, WA1 4 RQ

London Design Centre, 79 Margaret street, Fitzrovia, London, W1W 8TA



TED TODD